



ver.1.0_09/2023

Solopharm Product Catalog

Retail segment



Contents

Solopharm Company	4
Liquid Plant. Production of liquid dosage forms	8
Solid Plant. Production of solid dosage forms	10
Biotech. Development of biotechnological products	12
Food supplement. Production of food supplements	14
ANTISEPTICS	16
Zilexa sept	16
MestaMidin-sens	18
FOOD SUPPLEMENTS. GASTRO	20
Actoflor-duo	20
Actoflor-S	21
Viascon	21
FOOD SUPPLEMENTS. STICK PACKS	22
Magnesium Active	22
Lifožil	23
Chitosan Active	23
Lacart / Lacart Plus	24
Taprit / Taprit Plus	25
Rimink	26
Trieksin®	27
ELENTA NUTRITION®. FOOD SUPPLEMENTS IN CAPSULES	28
INFUSION SOLUTIONS	38
Glucose-Solopharm	39
Sodium Chloride-Solopharm	39
Moxifloxacin-Solopharm	39

RX — prescription medicines
OTC — over-the-counter medications

MD — medical devices
FS — food supplements

INJECTION SOLUTIONS	40
Sodium Chloride-Solopharm	40
Pentoxifylline	40
Glucose	40
Meldonium-Solopharm	40
Magnesium Sulfate	41
Potassium Chloride	41
Riboxin	41
Piracetam	42
Water for injection	42
Novocaine	42
Lidocaine	42
Diclofenac-Solopharm	43
Ketorolac-Solopharm	43
Calcium Gluconate-Solopharm	43
Drotaverine-Solopharm	43
COSMETOLOGY	44
Bellarti® Hydrate	45
Bellarti® Lift	46
Bellarti® Estilla	47
NEUROLOGY	48
Artogystan	49
Larigama®	50
Lidamitol	51
Elox Solopharm	52
Rikling	53
Encetron-Solopharm	54
Evrin	55
OTORHINOLARYNGOLOGY	56
Angidak®	56
Angidak® sept	57
Angidak® forte	57
Gelangin® flex	58

Gelangin® nova	59
Ivilekt	60
Naphthyzine	60
Babyfrin®	61
Ryxint Rhino	61
Xylokt®-Solopharm	62
Oxyfrin	62
Naximin	63
Ropaxim	63
Olyfrin	64
MestaMidin®-nasal	65
Rhinostain®	66
Tramycent	67
LinAqua	68
Lorotox®	70
Niatira	71
Otolorin	71
OPHTHALMOLOGY	72
AquaOptic	73
Gylan comfort / ultra comfort	74
Gylan® extra	74
Biviart® soft / comfort / ultra	77
Dorzial	78
Dorzial plus	78
Oloridine	79
Ocusalin	79
Ivinac®-Solopharm	80
Trilaktan®	81
Dorzolan® solo	82
Pictorid-Solopharm	82
Oftarint	83
Sigida duo / crystal	83
Diclofenac-Solopharm	84
Korfecin-Solopharm	84

Timolol-Solopharm	84
Betaxolol-Solopharm	84
Cromicil®-Solopharm	85
Oftrix	85
Lafrax	85
Travaxal	85
Soloseptin sens	86
Stelfrin supra	87
Phenycamide	88
Sodium Sulfacil-Solopharm	89
Taflarint	89
Timilox®	89
Taustin	90
Exinta®	91
Vicsipin®	91
PULMONOLOGY	92
Astmasol® broncho	92
Astmasol® neo	93
Ingasalin®	94
Ingasalin® forte	95
Beraxol-Solopharm	96
Novatron / Novatron neo	97
RHEUMATOLOGY	98
ArmaViscon®	98
Artavisk	102
Sintalon	103
ACT Solopharm®	104
THERAPY	106
DeTriFerol	106
Trekrezan®	107
Picodinar	108
Tricombia	109
Soloneks	109

Solopharm Company



Solopharm is one of the largest Russian pharmaceutical companies producing medicines, medical devices in liquid and solid dosage forms, and food supplements in capsules and stick packs.

All Solopharm production sites are built in accordance with GMP standards:

- > Liquid Plant
- > Solid Plant
- > BioTech
- > Food Supplement

ISO GMP

- **Solopharm** has been awarded the status of a strategic enterprise of the pharmaceutical industry of Russia¹
- **16th place** in the Forbes ranking²
- **The fastest growing company** in the OTC segment³
- **Solopharm geography** counts 14 countries beyond Russia and 85 regions within the country
- **No. 1** in terms of growth rates in e-com⁴
- **TOP 10** corporations by growth in the retail commercial market⁵
- **4th place** among domestic manufacturers in terms of share growth⁶
- **No. 1** in terms of the growth rate of medical prescriptions⁷

Solopharm is a team of more than 1800 professionals united by one goal: to create high-quality domestic medicines.

To do this, the company implements the most advanced production technologies and develops new therapeutic areas.

1. List of strategically important enterprises of the Russian Federation 2020
2. Forbes rating, 20 best pharmaceutical companies of the Russian Federation – 2021
3. According to IQVIA, DSM Group, 2021
4. According to AlphaRM, by the end of 2022
5. According to AlphaRM, 2022
6. According to DSM Group, 2022
7. According to Ipsos, Q1 23-Q2 22



- Solopharm has more than 220 market authorization certificates in its portfolio and more than 250 medicines are under development and registration.
- In-house R&D department, analytical and microbiological laboratories provide full-cycle of pharmaceutical development: from the idea to the launch of technology into industrial production.
- Solopharm has its laboratories that monitor the quality of incoming raw materials at all stages of production and conducts quality control of final products.





Solpharm

We care for people



- **2011 / July 11**
Groundbreaking of the liquid dosage form plant
- **2014 / June 11**
Launch of the 1st stage. The 1st series of infusion solutions are released
- **2015 / July 13**
Launch of the 2nd stage. Production of ophthalmic and nasal products in multidose form
- **2017 / April 21**
Launch of the 3rd stage — 10 new production lines. The GMP certificate is received
- **2020 / January 27**
Opening of a new office in Moscow

- **2020 / February 17**
Launch of the MDI aerosol production line at the liquid dosage form plant
- **2020 / September 4**
Groundbreaking of the solid dosage form plant
- **2021 / March 4**
Opening of the laboratory of biotechnological developments and PSS (pilot-scale site)
- **2021 / December**
Launch of the new food supplements plant. 1st stage — stick packs
- **2022 / April 29**
Launch of the solid dosage form plant (tablets and capsules)

- **2023 / April**
Launch of the 4th stage of the liquid dosage form plant. Increasing the manufacturing facilities
- **2023 / April**
Launch of Matrix Wall, a new Solopharm project — production site for design, manufacture, and installation of clean rooms
- **2023 / April**
Launch of the 2nd stage of the food supplements plant. Production of food supplements in capsules
- **2023 / June 20**
Groundbreaking of the Hormones plant (production of hormonal drugs)

HORIZONS OF DEVELOPMENT

- **2023 / IV quarter**
Launch of the 1st stage of the soft dosage form plant (ointments and gels)
- **2025 / IV quarter**
Launch of the 2nd and 3rd stages of the soft dosage form plant and soft gelatine capsules production
- **2026 / I quarter**
Planned launch of the Hormones plant



Liquid Plant

RELEASE FORMS

- OSD bottles
- multidose bottles
- Polyflac (BFS infusion bottles)
- pre-filled syringes
- BOV aerosols
- MDI aerosols
- BFS unidoses
- metered drops
- metered sprays
- glass bottles
- BFS injection ampoules
- CBP injection ampoules
- etc.

21 500 m²
total area of the plant

8 248 m²
clean room
floor area

3,14 MW
electrical power
of production

28
production
lines

> 190
positions of medicines
and medical devices

240 million
packages per year

THERAPEUTIC AREAS

- > hematology
- > infections
- > cosmetology
- > neurology
- > otorhinolaryngology
- > ophthalmology
- > ophthalmosurgery
- > pulmonology
- > rheumatology
- > dentistry
- > therapy
- > surgery



Solid Plant

RELEASE FORMS

- capsules
- capsules with extended release
- tablets
- oro-dispersible tablets
- gastroresistant tablets
- film-coated tablets
- tablets with extended release
- etc



12 257 m²
total floor area of the plant

9 600 m²
clean room floor area

2 MW
electrical power of production

1
production line

109
medicines under development and registration

6
medicines in production

23 million
packages per year

THERAPEUTIC AREAS

- > allergology
- > gastroenterology
- > cardiology
- > neurology
- > antiviral therapy
- > psychiatry
- > pulmonology
- > rheumatology
- > urology
- > endocrinology





BioTech

Development of biotechnological products

THERAPEUTIC AREAS

- Oncology
- Autoimmune diseases
- Ophthalmology



1 300 m²
total area

1
production line

448 m²
clean room floor area

2
laboratories:
> bioprocess development
> analytical methods

170 m²
total area
of laboratory facilities

10
projects under development

BioTech laboratories are fit up with high-quality equipment by the world manufacturers:

- bioreactor systems
- cryostorages
- chromatography systems, etc.



Food supplement

2 release forms

Capsule:

- > The usual form of food supplement administration
- > High quality
- > Convenience of administration

Stick pack:

- > Individual single dose
- > Dose accuracy in combination with liquid form
- > Convenient to "Take & Go"

1 077 m²
total production area

3
production lines

667 m²
clean room floor area

51
positions in production

1,5 MW
electrical power of production

1,6 million
packages per year

- > Solopharm sets the same high-quality requirements for food supplements as for medicines, starting with active pharmaceutical ingredients and equipment ending with quality control



ZILEXA SEPT

OTC 0+



UNIVERSAL ANTISEPTIC FOR THE WHOLE FAMILY
Provides bacteriocidal, antiviral and antifungal effect

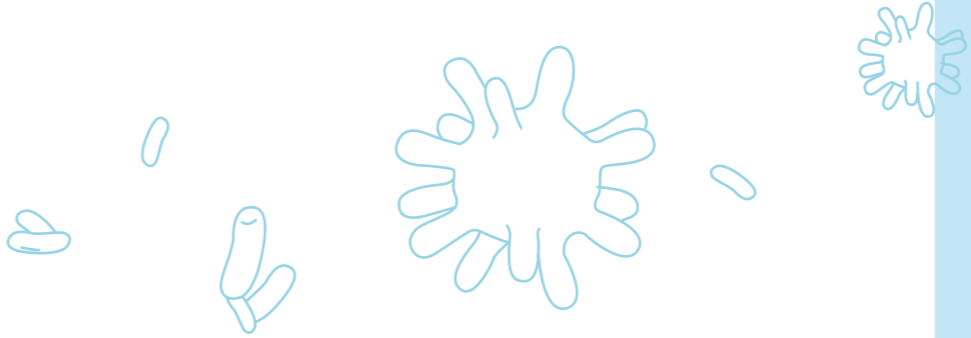

Composition:
Benzylidimethyl-myristoylammonium 0,01 %

Release form:
spray 50, 150 ml No. 1

Dosage form:
topically applied solution

- > Provides bacteriocidal, antiviral and antifungal effect
- > 50 ml bottle is convenient to carry
- > 150 ml bottle is convenient for home use, also two nozzles are included — spraying device and cannula



Indications for use

- > **otorhinolaryngology:** complex treatment of acute and chronic external otitis, sinusitis, tonsillitis, laryngitis, pharyngitis
- > **dentistry:** treatment and prevention of infectious and inflammatory diseases of the oral cavity: stomatitis, gingivitis, periodontitis
- > **surgery:** prevention of suppuration and treatment of purulent wounds
- > **dermatology:** treatment and prevention of pyoderma and dermatomycosis, candidiasis of the skin and mucous membranes, athlete's foot

ZILEXA SEPT intim

OTC 0+

Composition:
Benzylidimethyl-myristoylammonium 0,01 %

Release form:
dropper bottle 50 No. 1

Dosage form:
topically applied solution

- > Provides bacteriocidal, antiviral and antifungal effect
- > 50 ml bottle is convenient to carry
- > It has two nozzles — gynecological and urological



Indications for use

- > **obstetrics and gynecology:** prevention and treatment of suppuration of postpartum injuries, ostpartum infections, inflammatory diseases
- > **urology:** complex treatment of acute and chronic urethritis and specific urethroprostatitis and non-specific etiology
- > **venereology:** individual prevention of sexually transmitted diseases

MESTAMIDIN-SENS

OTC 0+

Composition:
octenidine dihydrochloride,
phenoxyethanol

Dosage form:
solution for local
and external use

TRIPLE ACTION ANTISEPTIC

It contains two powerful antiseptics that enhance the antimicrobial effect of each other and prevent the development of resistance of pathogens



Personal

Release form:
bottle with folding cannula
50, 150 ml

Indications for use

> for irrigation of the mucous membranes of the mouth, nose and throat, as well as for use in urology and gynecology



Home

Release form:
dropper bottle 50, 100 ml

Indications for use

> urology and gynecology



Daily

Release form:
bottle with spray device
50, 150 ml

Indications for use

> for irrigation of mucous membranes and skin



XXL

Release form:
bottle 1000 ml No. 12

Indications for use

> for use in medical institutions



ACTOFLOL-DUO

FS 18+ NEW

Composition:
amino acids, vitamins B₂ and B₉ in the complex with succinic acid

Release form:
capsules in jar No. 30, a set of two jars

- > Increases the vitality of the body and strengthens the immune system
- > Provides a positive effect on the state of the nervous system by regulating mental activity, mood and sleep



Indications for use

- > promotes the restoration of intestinal microflora
- > helps prevent side effects of taking antibiotics



Indications for use

- > helps to reduce heartburn, normalizes the acidity of gastric juice, improves digestion
- > additional source of calcium, soluble dietary fiber (alginates)



- > promotes the improvement of metabolism
- > increases the body's overall resistance to infections and stress

VIASCON

FS 18+

Composition:
sodium alginate, calcium carbonate, sodium bicarbonate

Release form:
stick packs 10 ml No.12

Dosage form:
liquid for oral administration

- > Contains soluble dietary fiber, which promotes the elimination of toxins from the body
- > Creates a protective barrier on the surface of the gastric contents, preventing the occurrence of reflux

ACTOFLOL-S

FS 18+

Composition:
a complex of amino acids and organic acids — analogues of metabolites of probiotic bacteria

Release form:
BFS unidose 2 ml No. 30

Dosage form:
solution for oral administration

- > Stimulation of growth of own intestinal microflora
- > Increase of physiological activity
- > Protection against pathogenic microorganisms



MAGNESIUM ACTIVE

FS 18+



Composition:
magnesium 100 mg,
vitamin B₆ 6 mg,
vitamin D₃ 600 ME



Release form:
stick packs 10 ml No. 10, 30

Dosage form:
liquid for oral administration



- > The form of magnesium bisglycinate is better absorbed
- > Comfort for the digestive system



Indications for use

- > relieving nervous tension
- > maintaining brain function during intellectual and neuro-emotional stress

LIFOZIL

FS 18+



Composition:
hesperidin 50 mg, diosmin 450 mg,
vitamin C 90 mg, grape seed extract



Release form:
stick packs 10 ml No. 14

Dosage form:
liquid for oral administration



- > Synergy of components with venoprotective properties
- > Grape seed extract helps strengthen the walls of blood vessels

CHITOSAN ACTIVE

FS 18+



Composition:
inulin 833,3 mg, pectin 150 mg,
chitosan 150 mg



Release form:
stick packs 10 ml No.30

Dosage form:
liquid for oral administration



- > Comprehensive bowel support in a convenient liquid form
- > Three types of dietary fiber in the composition



Indications for use

- > reduction of absorption of carbohydrates and fats
- > normalization of digestive processes

LACART

FS

3+

Composition:

calcium 800 mg,
vitamin D₃ 200 ME,
vitamin K₁ 20 mcg

Release form:

stick pack 10 ml No. 14, 28

Dosage form:

liquid for oral administration

- > Liquid calcium in organic mineral form for effective absorption
- > In the complex with vitamins K₁ and D₃



Indications for use

- > for healthy work of spine and joints
- > strengthening bones and teeth

Fe
B

Additional source of iron, C, B₁, B₂, B₆, B₁₂, vitamins, flavonoids

Taprit

14 stick packs x 10 ml

with briar flavor



Indications for use

- > prevention of anemia
- > saturation of the body with energy

TAPRIT

FS

18+

Composition:

iron 8 mg, vitamin C 60 mg,
B vitamins

Release form:

stick packs 10 ml No.14, 28

Dosage form:

liquid for oral administration

- > Chelated form of divalent iron with minimal risk to the gastrointestinal tract
- > Increased bioavailability
- > In combination with vitamins B and C

LACART PLUS

FS

18+

Composition:

calcium 850 mg,
vitamin D₃ 600 ME,
vitamin K₂ 150 mcg

Release form:

stick pack 10 ml No. 14, 28

Dosage form:

liquid for oral administration

- > Easily digestible liquid form
- > Enhanced dosages



Indications for use

- > strengthening of musculoskeletal tissue

Fe
B

Additional source of iron, C, B₁, B₂, B₆, B₁₂, vitamins, contains rosmarinic acid

Taprit Plus

14 stick packs x 10 ml

with briar flavor



Indications for use

- > prevention of anemia
- > saturation of the body with energy

TAPRIT PLUS

FS

18+

NEW

Composition:

iron 40 mg, vitamin C 360 mg,
B vitamins

Release form:

stick packs 10 ml No.14, 28

Dosage form:

liquid for oral administration

- > Easily digestible liquid form
- > Enhanced dosages

RIMINK

FS 18+

Composition:
vitamin D₃ 600 ME,
vitamin E 1 mg

Release form:
stick packs 5 ml No.14, 28

Dosage form:
liquid for oral administration

Liposomal forms of vitamins contribute to their better absorption

LIPOSOME

- Prevents premature destruction of vitamins
- Protects vitamin from the effects of the gastrointestinal tract environment

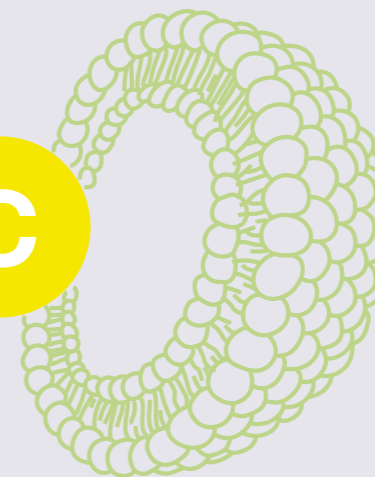

TRIEKSIN®

FS 18+

Composition:
vitamin C 900 mg

Release form:
stick packs 10 ml No.14, 28

Dosage form:
liquid for oral administration



Indications for use

- > strengthening immunity
- > improving the condition of the musculoskeletal system

Indications for use

- > vitamin C deficiency in the body
- > strengthening immunity
- > maintaining skin health
- > tissue growth and healing

- > Liposomal vitamin C 900 mg to support immunity
- > Liposomal form promotes better absorption of vitamin C, protects it from destruction in the gastrointestinal tract

Elentra Nutrition®



Elentra Nutrition® is a synergy of science, high-tech production of the pharmaceutical company and strict pharmacopoeia standards that ensure the achievement of impeccable product quality

Elentra Nutrition® is represented by a wide range of nutrients for the most diverse needs of a modern human



Reliability and quality of packaging



Indications for use

- > relieving nervous tension
- > improving sleep quality
- > serotonin formation



Indications for use

- > maintenance of iron metabolism
- > increasing energy levels and improving oxygen metabolism

5-HTP + VITAMIN B₆

FS 18+

Composition:
hydroxytryptophan (5-HTP) 100 mg,
vitamin B₆ 6 mg

Release form:
capsules in jar No. 60

- > The synergy of 5-HTP and vitamin B₆ components has a better effect on stress and anxiety
- > Vitamin B₆ is a cofactor in the process of converting 5-HTP into serotonin
- > Small capsule size
- > Once daily administration

IRON + VITAMIN C

FS 18+

Composition:
iron 20 mg, vitamin C 90 mg

Release form:
capsules in jar No. 60

- > The organic chelated salt of the mineral helps to minimize the risk of exposure to the stomach and a higher rate of absorption among other salts
- > Gastro-resistant capsules with extended release

COENZYME Q₁₀ + VITAMIN C

FS 18+

Composition:
coenzyme Q₁₀ 100 mg, vitamin C 20 mg

Release form:
capsules in jar No. 30

- > Vitamin C enhances the action of coenzyme Q₁₀ and improves its absorption
- > Small capsule size



Indications for use

- > promotes the maintenance of the function of heart and blood vessels, renewal of skin cells



Indications for use

- > comprehensive maintenance of thyroid functions
- > increasing mental activity

IODINE + TYROSINE

FS 18+

Composition:
iodine 225 mcg, tyrosine 500 mg

Release form:
capsules in jar No. 60

- > The synergy of iodine and tyrosine forms a complex effect to maintain the functioning of the thyroid gland
- > The optimal dosage of iodine

MAGNESIUM CHELATE

FS 18+

Composition:
magnesium chelate 90 mg

Release form:
capsules in jar No. 90

- > The organic chelated salt of the mineral, magnesium bisglycinate helps to minimize the risk of exposure to the stomach and a higher rate of absorption among other salts



Indications for use

- > maintenance of the function of heart and blood vessels
- > helps relieve muscle spasms



Indications for use

- > promotes the strengthening of immunity, health of hair, nails, skin

ZINC + SELENIUM

FS 18+

Composition:
zinc 15 mg, selenium 75 mcg

Release form:
capsules in jar No. 30

- > The organic chelated salts of the mineral help to minimize the risk of exposure to the stomach and a higher rate of absorption among other salts
- > Small capsule size
- > Once daily administration



CHITOSAN + CHROMIUM

FS 18+

Composition:
chitosan 500 mg, chromium 83 mcg

Release form:
capsules in jar No. 90

- > The organic salt of the mineral helps to minimize the risk of exposure to the stomach and a higher rate of absorption among other salts
- > Natural source of chitosan — seafood



Indications for use

- > a combination to maintain metabolism
- > helps reduce the absorption of carbohydrates and fats

B COMPLEX

FS 18+

- > The complex includes all the necessary B vitamins to maintain the body in a healthy state
- > A set of two products for morning and evening administrations

Composition:
B vitamins

Release form:
capsules in jar No. 30, two jars “morning” and “evening”

L-LYSINE

FS 18+

- > Stimulates collagen production and supports the immune system
- > The amino acid in free L-form contains the optimal level of consumption for adults per day

Composition:
L-lysine 500 mg

Release form:
capsules in jar No. 60

FS 18+

CHONDROBASE®

Composition:
glucosamine 290 mg,
chondroitin 315 mg

Release form:
capsules in jar No. 90

- > Promotes the natural processes of maintaining bone and cartilage tissues and improving the condition of the musculoskeletal system
- > Optimal dosages for starting support of the musculoskeletal system

FS 18+

CHONDROBASE® MSM

Composition:
chondroitin 315 mg,
glucosamine 290 mg,
methylsulfonylmethane
(MSM) 135 mg

Release form:
capsules in jar No. 90

- > Helps to maintain joint mobility and natural renewal of cartilage tissue
- > Sulfur (source of Methylsulfonylmethane (MSM)) has an anti-inflammatory effect in combination with glucosamine and chondroitin

FS 18+

BIOTIN

Composition:
vitamin B₇ 150 mcg

Release form:
capsules in jar No. 60

- > Promotes the maintenance of healthy skin, hair and nails
- > The optimal dose of biotin for adults per day
- > Convenient once daily administration of vitamin B₇

FS 18+

INDOLE-3-CARBINOL

Composition:
indole-3-carbinol 300 mg

Release form:
capsules in jar No. 60

- > Provides a beneficial effect on the state of the reproductive system of both women and men
- > The optimal level of consumption per day for adults

INOSITOL

FS 18+

- > Promotes the metabolism of carbohydrates and lipids, supports the healthy functioning of the nervous system
- > The optimal level of consumption for adults per day

Composition:
inositol 500 mg

Release form:
capsules in jar No. 60

POTASSIUM + MAGNESIUM ASPARTATE

FS 18+

- > Maintenance of the function of heart and blood vessels
- > Optimal preventive dosages

Composition:
potassium aspartate 100 mg,
magnesium aspartate 50 mg

Release form:
capsules in jar No. 120

MAGNESIUM + VITAMIN B₆

FS 18+

- > Promotes concentration and memory improvement, supports the function of heart and blood vessels
- > Vitamin B₆ potentiates the action of magnesium, transfers magnesium inside the cell

Composition:
magnesium 80 mg,
vitamin B₆ 2 mg

Release form:
capsules in jar No. 90

MAGNESIUM + CALCIUM CHELATE

FS 18+

- > Helps strengthen bones and supports the function of heart and blood vessels
- > The chelated form of magnesium provides a higher rate of absorption, with minimal risk of exposure to the gastrointestinal tract

Composition:
magnesium chelate 50 mg,
calcium chelate 100 mg

Release form:
capsules in jar No. 90

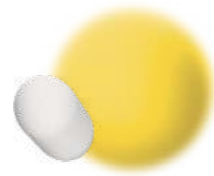

FS 18+

ZINC PICOLINATE



Composition:
zinc picolinate 25 mg

Release form:
capsules in jar No. 90

- > Helps strengthen the immune system
- > The organic chelated salt of the mineral helps to minimize the risk of exposure to the stomach and a higher rate of absorption among other salts

FS 18+

CHROMIUM NICOTINATE



Composition:
chromium nicotinate 250 mcg

Release form:
capsules in jar No. 90

- > Helps optimize carbohydrate metabolism and maintain energy metabolism
- > An organic salt of the mineral is used — nicotinate, which has increased bioavailability
- > In the presence of nicotinic acid, chromium absorption increases several times, contributing to the maintenance of carbohydrate and energy metabolism

FS 18+

LIPOSOMAL ZINC



Composition:
zinc 12,5 mg

Release form:
capsules in jar No. 60

- > Prevents disturbances in the work of enzyme systems and the metabolic system: protein, carbohydrate, mineral and energy



LIPOSOMAL D₃+K₂

- > Liposomal complex D₃+K₂ for the maintenance of the musculoskeletal system



FS 18+

D-MANNOSE TRIO

FS 18+ NEW

- > Comprehensive maintenance of the urinary tract health



Composition:
vitamin D₃ 15 mcg, vitamin K₂ (menaquinone) 180 mcg

Release form:
capsules in jar No. 60



Composition:
D-mannose, bearberry, cranberry

Release form:
capsules in jar No. 60

INDOLE-3-CARBINOL + BROCCOLI EXTRACT

FS 18+ NEW

- > Maintaining the health of the reproductive system



Composition:
indole-3-carbinol 300 mg, broccoli extract

Release form:
capsules in jar No. 60

Infusion solutions in POLYFLAC polymer bottles

- **GUARANTEE OF STERILITY**
Final sterilization in 20 minutes at 121 °C
- **BFS TECHNOLOGY (Blow-Fill-Seal)**
- **INERT MATERIAL**
Durable, lightweight and convenient



GLUCOSE-SOLOPHARM

- RX 0+
- Dextrose 5 %
- BFS infusion bottle 200, 400 ml
- Solution for infusions



SODIUM CHLORIDE-SOLOPHARM 0,9 %

- RX 0+
- Rehydrating agent
- BFS infusion bottle 200, 400 ml
- Solution for infusions



MOXIFLOXACIN-SOLOPHARM 1,6 mg/ml

- RX 0+
- Antimicrobial agent — fluoroquinolone
- BFS infusion bottle 200, 250, 400 and 500 ml
- Solution for infusions

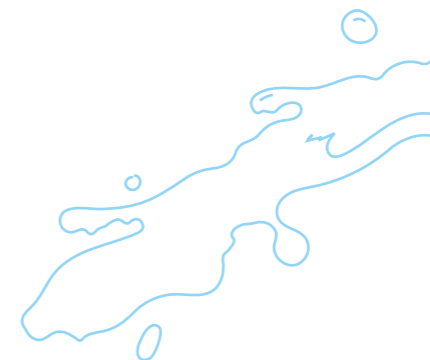

POLYPROPYLENE BFS INFUSION BOTTLES

Infusions are manufactured in one Blow-Fill-Seal cycle — advanced sterile filling technology

Sterile solutions in polymer packaging — a modern standard on the global pharmaceutical market

- > fully self-collapsible bottle
- > stable, due to the flat bottom
- > does not contain polyvinyl chloride
- > there is no risk of injury
- > convenient to store and transport
- > has a small package weight

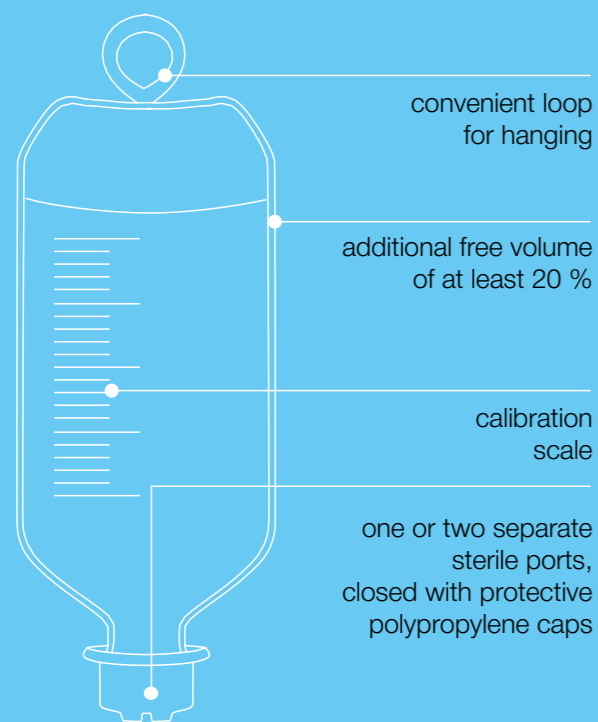

Solopharm injection solutions

are produced in polyethylene ampoules manufactured using modern BFS technology, recognized in the world as the most advanced for the production of sterile medicinal solutions

ADVANTAGES:

- The use of medicines in BFS polyethylene ampoules is convenient and safe for patients and medical workers
- Convenient opening without contamination due to the ergonomic valve
- No additional needle required
- High speed of injection due to the ease of opening
- Reliable marking applied directly to the ampoule

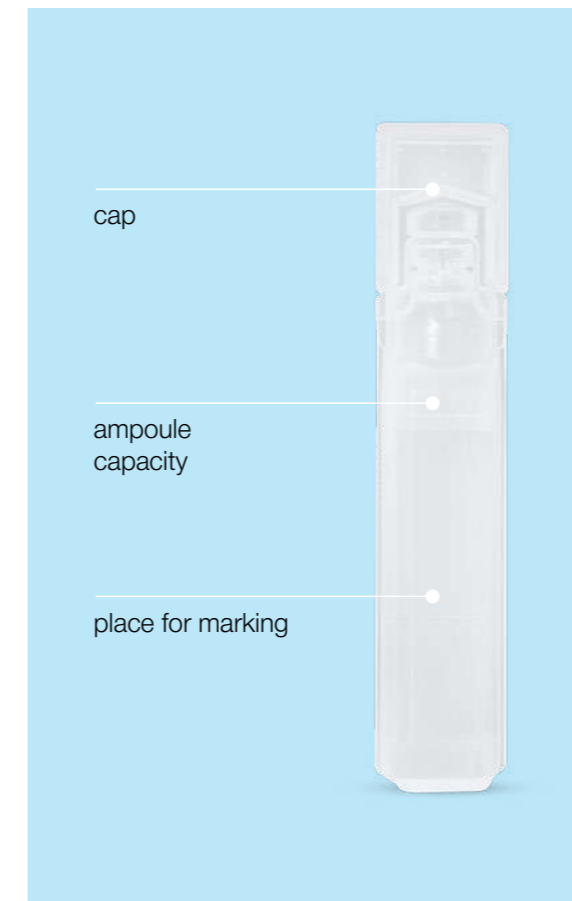

POLYETHYLENE BFS AMPOULES (Blow-Fill-Seal) is a needle-free drug intake

BFS technology

allows producing a container for a solution of polyethylene, filling and sealing it using one machine

The process, protected by injected sterile air and special filters, takes place without human intervention, which makes it possible to provide the necessary aseptic conditions

SODIUM CHLORIDE-SOLOPHARM 0,9 %

RX

- Rehydrating agent
- BFS injection ampoules 5 ml No. 5, 10
- Solvent for injection preparation

GLUCOSE

RX

- Dextrose 400 mg/ml
- Means of carbohydrate nutrition
- BFS injection ampoules 10 ml No. 10
- Solution for intravenous administration

MAGNESIUM SULFATE 250 MG/ML

RX

- Vasodilating agent
- BFS injection ampoules 5, 10 ml No. 10
- Solution for intravenous administration

RIBOXIN

RX

- Inosine 20 mg/ml
- Metabolic agent
- BFS injection ampoules 5, 10 ml No. 10
- Solution for intravenous administration

PENTOXIFYLLINE 20 MG/ML

RX

- Vasodilating agent
- BFS injection ampoules 5 ml No. 10
- Concentrate for preparation of solution for infusions

MELDONIUM-SOLOPHARM 100 MG/ML

RX

- Metabolic agent
- BFS injection ampoules 5 ml No. 10
- Solution for injection

POTASSIUM CHLORIDE 40 MG/ML

RX

- Potassium preparation
- BFS injection ampoules 10 ml No. 10
- Concentrate for preparation of solution for infusions



POLYETHYLENE BFS AMPOULES —
a needle-free drug intake

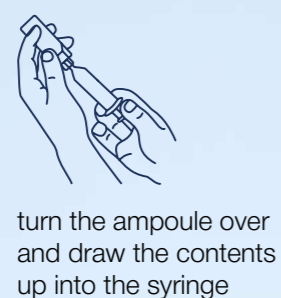
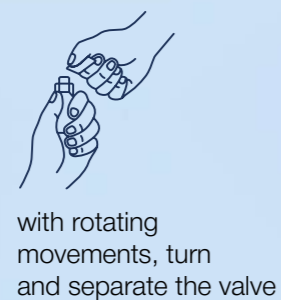

PIRACETAM 200 MG/ML

RX

- Nootropic agent
- BFS injection ampoules 5 ml No. 10
- Solution for intravenous injection

WATER FOR INJECTION

RX

- Solvent
- BFS injection ampoules 5, 10 ml No. 5, 10
- Solvent for injection preparation

NOVOCAINE

RX

- Procaine 0.5 %
- Local anesthetic
- BFS injection ampoules 5 ml No. 10
- Solution for injection

LIDOCAINE 20 MG/ML

RX

- Vasodilating agent
- BFS injection ampoules 2 ml No. 10
- Solution for injection



CBP (Colour Break Point) —
modern opening system, guarantee of ease, speed and safety of opening a glass ampoule

ADVANTAGES OF CBP AMPOULES

- > no risk of foreign bodies
- > opening in difficult conditions without a file and a scarifier
- > high speed of injection due to the simplicity of opening
- > opening in poor light — the possibility of a fracture in any direction

DICLOFENAC-SOLOPHARM 25 MG/ML

RX

- Nonsteroidal anti-inflammatory agent
- CBP injection ampoules 3 ml No. 5
- Solution for intramuscular injection

KETOROLAC-SOLOPHARM 30 MG/ML

RX

- Nonsteroidal anti-inflammatory agent
- CBP injection ampoules 1 ml No. 10
- Solution for intravenous and intramuscular injection

CALCIUM GLUCONATE-SOLOPHARM 100 MG/ML

RX

- Calcium preparation
- CBP injection ampoules 5, 10 ml No. 10
- Solution for intravenous and intramuscular injection

DROTAVERINE-SOLOPHARM 20 MG/ML

RX

- Antispasmodic agent
- CBP injection ampoules 2 ml No. 10
- Solution for intravenous and intramuscular injection

Bellarti®

Born to shine

Hyaluronic Acid

- Only premium HTL hyaluronic acid (France) is used
- The unique AFT technology (aseptic filling technology) and a special steam sterilization mode make it possible to obtain a hyaluronic acid molecule that is resistant to mechanical and enzymatic destruction with a weight of at least 2.7 mDa
- Ergonomic shape of the syringe and the pH related to the dermis make the procedure comfortable for both doctors and patients



Indications for use

- > increases the hydration and elasticity of the skin
- > compensates for the loss of hyaluronic acid due to age-related changes

Pre-filled syringe

- > Ultra-thin laser-sharpened needles to minimize skin injury during injection
- > Convenient ergonomics of the syringe (smoothness of the piston stroke, colored rods) for the comfort of the doctor
- > Glass cylinder for convenience and accuracy of dosing
- > Reinforced stock

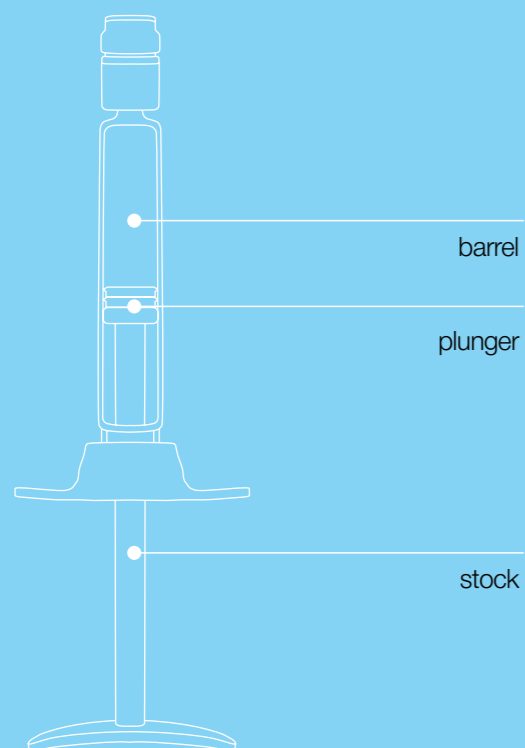

BELLARTI® HYDRATE

MD

18+

Composition:

sodium hyaluronate 1,35 %, mannitol 0,49 %

Release form:

pre-filled syringe
1, 2 ml No. 1

Dosage form:

intra-dermal implant

- > A preparation based on premium hyaluronic acid for classical biorevitalization
- > Provides rapid saturation of the skin with moisture, improvement of complexion, restoration of elasticity and skin tightness
- > Suitable for combination with other cosmetology procedures

BELLARTI® LIFT

MD

18+

Composition:

sodium hyaluronate 1,8 %,
glycerol 0,9 %

Release form:

pre-filled syringe 1, 2 ml No. 1

Dosage form:

intra-dermal implant

> A preparation based on premium hyaluronic acid for prolonged biorevitalization and correction of surface wrinkles

> Provides rapid saturation of the skin with moisture, correction of surface wrinkles, improvement of complexion, restoration of elasticity and skin tightness

> Suitable for combination with other cosmetic procedures

Indications for use

> increases the hydration, tone and elasticity of the skin, fills in fine wrinkles, such as «crow's feet» or «pouch» wrinkles

BELLARTI® ESTILLA

MD

18+

NEW

Composition:

polylactic acid 1 %,
sodium hyaluronate 0,75 %

Release form:

pre-filled syringe 1, 2 ml No. 1

Dosage form:

intra-dermal implant

> Preparation for replenishment and creation of additional volume, correction of age-related changes in the skin, as well as to increase its hydration and elasticity

Indications for use

> increases the volume of atrophic areas, incl. the correction of skin defects such as wrinkles, furrows, scars and age-related changes

> for volume correction with signs of thinning of facial adipose tissue (lipoatrophy)



Solpharm neurological portfolio

is represented by two therapeutic groups:

- Medicines for the treatment of cerebrovascular diseases
- Medicines for the treatment of diseases of the musculoskeletal system

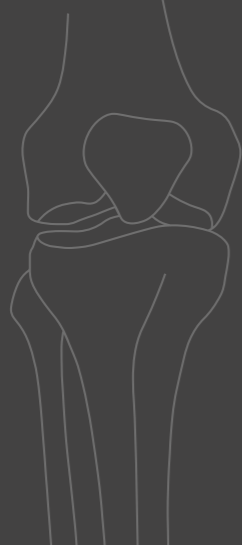

The portfolio includes the most popular drugs that are widely used in medical practice and are included in the standards of treatment of neurological diseases:

- > nonsteroidal anti-inflammatory drugs
- > central action muscle relaxant
- > B vitamins
- > chondroprotector
- > nootropic drug
- > antioxidant



Indications for use

- > degenerative-dystrophic diseases of the joints and spine: osteoarthritis and osteochondrosis of the spine
- > accelerates the formation of callus in fractures

ARTOGYSTAN

RX

18+



Composition:
chondroitin sulfate 100 mg/ml



Release form:
CBP injection ampoules
1, 2 ml No. 10, 20



Dosage form:
solution for intramuscular injection



Chondroitin from the reference substance for the correct treatment of osteoarthritis

Is recommended as a basic therapy for osteoarthritis from the first step and at all subsequent stages of treatment:

- > reduces pain and inflammation
- > prevents the destruction of cartilage
- > improves mobility of affected joints
- > helps reduce the need for NSAIDs

Does not contain benzyl alcohol

Thoughtful forms of release for initial and course therapy

LARIGAMA®

RX 18+

Composition:
pyridoxine, thiamine,
cyanocobalamin, lidocaine

Release form:
CBP injection ampoules
2 ml No. 5, 10

Dosage form:
solution for intramuscular
injection

**Neurotropic complex
of B vitamins:**

- > has an anti-inflammatory and analgesic effect
- > promotes the restoration of nerve fibers
- > improves nerve impulse conduction
- > enhances the effect of NSAIDs



Indications for use

- in complex therapy:
- > mono- and polyneuropathies of various genesis
 - > dorsalgia
 - > plexopathy
 - > lumboschialgia
 - > radicular syndrome caused by degenerative changes in the spine

LIDAMITOL

RX 18+

Composition:
tolperizone 100 mg/ml,
lidocaine 2,5 mg/ml

Release form:
BFS injection ampoules
1 ml No. 5, 10

Dosage form:
solution for intravenous
and intramuscular injection

**The only injectable tolperisone,
which is available in BFS
ampoules, which meets
modern standards on the global
pharmaceutical market**

- > reduces muscle spasm
- > enhances the effect of NSAIDs
- > does not have a sedative effect
- > release form provides fast, convenient and safe opening of the ampoule



Indications for use

- > symptomatic treatment of adult stroke-related spasticity
- > myofascial pain syndrome of moderate and severe degree (including muscle spasm in dorsopathies)

ELOX SOLOPHARM

RX 18+

Composition:
meloxicam 10 mg/ml

Release form:
BFS injection ampoules
1,5 ml No. 5

Dosage form:
solution for intramuscular
injection

- Nonsteroidal anti-inflammatory drug:**
- > affects the key stages of the inflammatory cascade
 - > favorable profile of gastro- and cardiac safety
 - > release form provides fast, convenient and safe opening of the ampoule



Indications for use

- initial therapy and short-term symptomatic treatment:
- > with osteoarthritis (arthrosis, degenerative joint diseases)
 - > rheumatoid arthritis
 - > ankylosing spondylitis
 - > other inflammatory and degenerative diseases of the musculoskeletal system, accompanied by pain

Indications for use

- > symptomatic treatment of acute pain of severe and moderate intensity (for example, postoperative pain, lower back pain and renal colic) with the inexpediency of oral therapy

RIKLING

RX 18+

Composition:
dexketoprofen 25 mg/ml

Release form:
CBP injection ampoules
2 ml No. 5, 10

Dosage form:
solution for intravenous
and intramuscular injection

- > has analgesic, anti-inflammatory and antipyretic effect

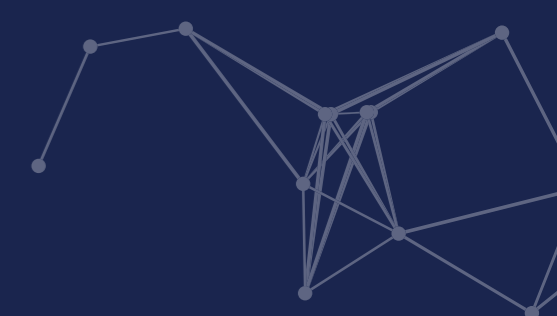

ENCETRON-SOLOPHARM

RX 18+

- Composition:** citicoline 100 mg/ml
- Release form:** BFS injection ampoules 10 ml No. 10
- Dosage form:** solution for oral administration

- Composition:** citicoline 125, 250 mg/ml
- Release form:** BFS injection ampoules 4 ml No. 5
- Dosage form:** solution for intravenous and intramuscular injection

The only citicoline for oral administration without flavorings in convenient BFS ampoules

- To maximize the potential of the brain:
- > improves memory
 - > increases concentration of attention
 - > improves brain function
 - > normalizes the emotional background



Indications for use

- > cognitive and behavioral disorders in degenerative and vascular diseases of the brain
- > acute period of ischemic stroke (as a part of complex therapy)
- > recovery period of ischemic and hemorrhagic strokes
- > traumatic brain injury, acute (as part of complex therapy) and recovery period



Indications for use

- > acute disorders of cerebral circulation (as part of complex therapy)
- > traumatic brain injury, the consequences of traumatic brain injuries
- > syndrome of autonomic (neurocirculatory) dystonia
- > anxiety disorders in neurotic and neurosis-like conditions
- > acute myocardial infarction (from the first day) as part of complex therapy

EVIRIN

RX 18+

- Composition:** ethylmethylhydroxypyridine succinate 50 mg/ml
- Release form:** CBP injection ampoules 2 ml No. 10, 5 ml No. 5
- Dosage form:** solution for intravenous and intramuscular injection

- Composition:** ethylmethylhydroxypyridine succinate 125 mg/ 250 mg

- Release form:** tablets in a blister, No. 30, 40, 50, 60

- > Improves metabolism and blood supply to the brain
- > Activates energy metabolism in cells
- > Stimulates reparative processes and limits the ischemic zone
- > Increases the body's resistance to the effects of damaging factors

The portfolio of otorhinolaryngology includes

- Antibacterial and anti-inflammatory drugs for mouth cavity and throat
- Moisturizing and antiseptic products for the nasal cavity
- Vasoconstrictive drugs, including combined and non-preservative
- Drugs for the treatment of otitis



ANGIDAK®

- > Helps to reduce sore throat from the 1st minute
- > Additionally provides an antiseptic effect
- > Wide spray angle to deliver the drug precisely to the target
- > A convenient bottle with a folding nozzle that will not be lost

- Indications for use of Angidak®, Angidak® sept, Angidak® forte:**
- > pharyngitis, laryngitis, tonsillitis
 - > stomatitis, candidiasis of the oral cavity
 - > gingivitis, glossitis, periodontal disease
 - > after treatment and removal of teeth



ANGIDAK®



OTC 3+

- Composition:** benzidamine 0,255 mg/dose
- Release form:** metered spray 30 ml
- Dosage form:** spray for topical use
- Wide spray angle to deliver the drug precisely to the target

ANGIDAK® SEPT



OTC 12+

- Composition:** benzidamine 0,15 %
- Release form:** glass bottle 150 ml
- Dosage form:** solution for topical application
- For mechanical cleansing of the mucosa from pathogens of infection



ANGIDAK® FORTE



OTC 18+

- Composition:** benzidamine 0,51 mg/dose
- Release form:** metered spray 30 ml
- Dosage form:** spray for topical use
- Enhanced formula with economical consumption

GELANGIN®

- > Antiseptic for the treatment of mouth and throat infections
- > Acts on the cause of pain and inflammation: viruses, bacteria and fungi
- > Maintains an active concentration during 12 hours and can be applied only twice a day
- > Provides a mild anesthetic effect

Indications for use

- > tonsillitis, angina, pharyngitis, gingivitis, stomatitis, glossitis, periodontal disease
- > fungal diseases
- > prevention of complications before and after surgical interventions on the oral cavity and larynx, including after tooth extraction
- > oral hygiene

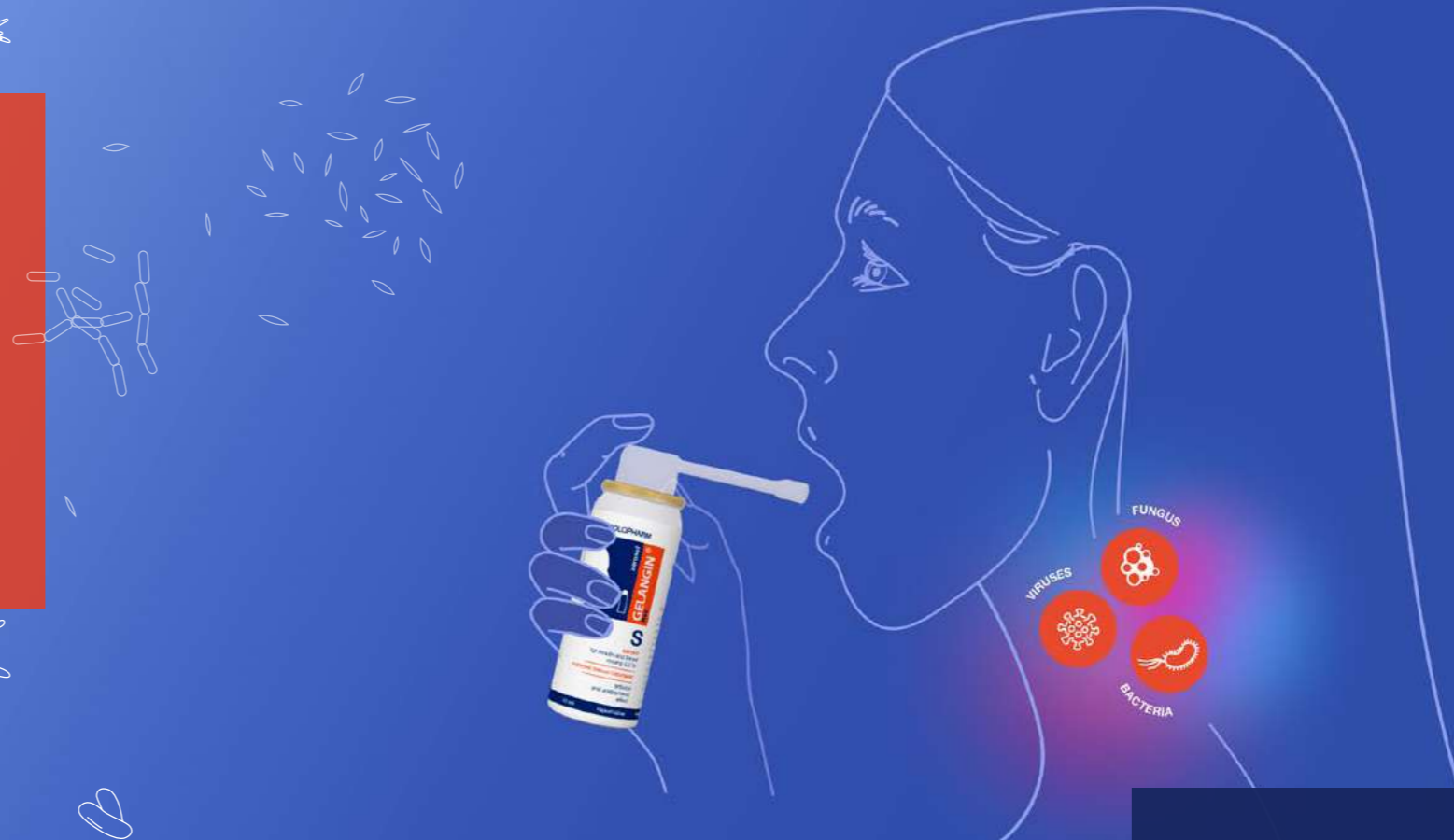

GELANGIN® FLEX

OTC 3+

Composition:
hexethidine 0,2 %

Release form:
aerosol 40 ml No. 1

Dosage form:
aerosol for topical use



GELANGIN® NOVA

OTC 3+

Composition:
hexethidine 0,1 %

Release form:
glass bottle 200 ml No. 1

Dosage form:
solution for topical use



IVILEKT

OTC

18+

Composition:
naphazoline 0,1 %

Release form:
metered spray 10 ml No. 1

Dosage form:
nasal spray

- > Facilitates breathing within 5 minutes, the effect lasts up to 5 hours
- > Provides an additional cooling effect, which gives a feeling of freshness

**Indications for use**

- > acute rhinitis (including against the background of acute respiratory diseases)
- > allergic rhinitis
- > sinusitis



NAPHTHYZINE

OTC

2+

Composition:
naphazoline 0,05 %, 0,1 %

Release form:
10 ml multidoses No. 1

Dosage form:
nasal drops

Russian first seawater-based naphazoline

**Indications for use**

- > acute rhinitis (including against the background of acute respiratory diseases)
- > allergic rhinitis
- > sinusitis

BABYFRIN®

OTC

0+

Composition:
phenylephrine 0,125 %

Release form:
multidoses 10 ml No. 1

Dosage form:
nasal drops

Mild vasoconstrictor effect for the youngest patients

- > Affects only α -1 receptors
- > Suitable for children from birth

**Indications for use**

- > acute sinusitis
- > acute rhinitis
- > acute otitis media (as part of combination therapy)

**Indications for use**

- > acute respiratory diseases accompanied by rhinitis
- > allergic rhinitis
- > vasomotor rhinitis

RYXINT RHINO

OTC

0+

1+

6+

Composition:
oxymetazoline 0,01 %/
0,025 %/ 0,05 %

Release form:
pipette bottle 10 ml No. 1

Dosage form:
nasal drops

Treatment of rhinitis against the background of acute respiratory viral infections and allergies

- > The effect up to 12 hours
- > Release forms for all ages

XYLOKT®- SOLOPHARM

OTC 2+ 6+

- Composition:**
xylometazoline 0,05 %, 0,1 % /
35 mcg/dose, 140 mcg/dose
- Release form:**
multidoses 10 ml No. 1
- Dosage form:**
nasal drops
- Release form:**
metered spray 15 ml No. 1
- Dosage form:**
nasal spray
- Pronounced vasoconstrictive effect in case of rhinitis and severe nasal congestion**
 - > The effect up to 10 hours
 - > Release forms for adults and children — drops and sprays



- Indications for use**
- > acute respiratory diseases with rhinitis
 - > allergic rhinitis
 - > pollinosis
 - > sinusitis

OXYFRIN

OTC 1+ 6+ no preservatives

- Composition:**
oxymetazoline 11,25 mcg/dose,
22,5 mcg/dose
- Release form:**
metered spray 15 ml No. 1
- Dosage form:**
nasal spray
- Gentle and the longest recovery of nasal breathing**
 - > Line of remedies in case of rhinitis for adults and children
 - > The effect up to 12 hours
 - > The special design of the bottle ensures accurate dosing in the form of a “cloud” and avoids the use of preservatives



- Indications for use**
- > acute respiratory diseases with rhinitis
 - > acute allergic rhinitis
 - > exacerbation of vasomotor rhinitis



- Indications for use**
- > acute respiratory diseases with rhinitis
 - > allergic rhinitis
 - > pollinosis
 - > sinusitis
 - > eustachitis

NAXIMIN

OTC 2+ 6+ no preservatives

- Composition:**
xylometazoline 0,05 mg, dexpanthenol 5 mg/dose
xylometazoline 0,1 mg, dexpanthenol 5 mg/dose
- Release form:**
metered spray 15 ml No. 1
- Dosage form:**
nasal spray
- Vasoconstrictor drug with additional protection for sensitive nasal mucosa**
 - > The effect up to 10 hours

ROPAXIM

OTC 18+ no preservatives

- Composition:**
ipratropium bromide 84 mcg/dose,
xylometazoline 70 mcg/dose
- Release form:**
metered spray 15 ml No. 1
- Dosage form:**
nasal spray
- In case of rhinitis and strong nasal flow**
 - > Relieves congestion and stops the flow from the nose
 - > Starts working in 5 minutes and provides a long lasting effect up to 8 hours



- Indications for use**
- > symptomatic treatment of edema and hyperemia of the nasal cavity
 - > acute respiratory diseases with rhinitis

OLYFRIN

MD 3+



Composition:
sodium hyaluronate 1,9 mg,
vitamin E, lemon oil

Release form:
metered spray 15 ml No. 1

Dosage form:
nasal spray

- > Moisturizes the nasal mucosa and creates a protective barrier when using vasoconstrictive drugs
- > Eliminates symptomatic manifestations of dryness (irritation, itching, burning)
- > Promotes healing of thinned mucosa and accelerates regeneration after surgical interventions



Indications for use

- > patients using vasoconstrictor drugs
- > in case of complaints upon dryness and discomfort in the nasal cavity
- > after surgical interventions in the nasal cavity

MESTAMIDIN®-NASAL

MD 1+



Composition:
octenidine dihydrochloride,
dexpanthenol, hydroxyethyl
cellulose

Release form:
pipette bottle 10 ml No. 1

Dosage form:
nasal drops

Protection against influenza viruses, ARVI and coronavirus

- > Universal antiseptic
- > Heals and restores the natural protection of the mucous membrane
- > Creates a physical barrier against infectious agents



Indications for use

- > creates a protective antiseptic barrier in the nasal cavity
- > accelerates the regeneration of the nasal mucosa after surgical interventions
- > maintains the physiological microclimate of the nasal cavity

RHINOSTAIN®

OTC 6+

Composition:
 acetylcysteine 10 mg/ml,
 tuaminoheptan 5 mg/ml,
 sodium hyaluronate 1 mg/ml

Release form:
 metered spray 10 ml No. 1

Dosage form:
 nasal spray

A unique combination of acetylcysteine, tuaminoheptane and hyaluronic acid for the treatment of rhinitis and sinusitis

- Provides a complex effect:
- > tuaminoheptan eliminates mucosal edema
 - > acetylcysteine dilutes and accelerates the evacuation of nasal secretions from the sinuses and nasal cavity
 - > hyaluronic acid moisturizes and protects the nasal mucosa, and also enhances the mucolytic effect of acetylcysteine



Indications for use

- > acute and subacute rhinitis with a thick purulent-mucous secret
- > sinusitis
- > chronic rhinitis
- > vasomotor rhinitis
- > atrophic rhinitis



Indications for use

- as a part of combination therapy in case of infections and inflammatory diseases of the upper respiratory tract, including:
- > rhinitis
 - > rhinopharyngitis
 - > sinusitis (in case of absence of nasal septum damage)

TRAMYCENT

RX 0+

Composition:
 framycetin 1,25 %

Release form:
 metered spray 15 ml No. 1

Dosage form:
 nasal spray

Antibacterial drug for the treatment of sinusitis for patients of all ages, ensuring accurate delivery and steady distribution of the drug in all parts of the nasal cavity

- > Active against the main causative agents of sinusitis
- > The special design of the bottle ensures spraying in the form of a "cloud", which allows delivering the drug to all parts of the nasal cavity, increasing the effectiveness of treatment
- > No age restrictions. Can be prescribed to patients of any age (0+)



LINAQUA

Natural sea water from the shores of France

- Contains 11 micro- and macronutrients, provides cleansing, antiseptic and anti-inflammatory effects
- No dyes, preservatives and harmful additives
- A wide range of release forms for adults and children from birth
- The "Bag on Valve" technology ensures the preservation of the beneficial properties of seawater

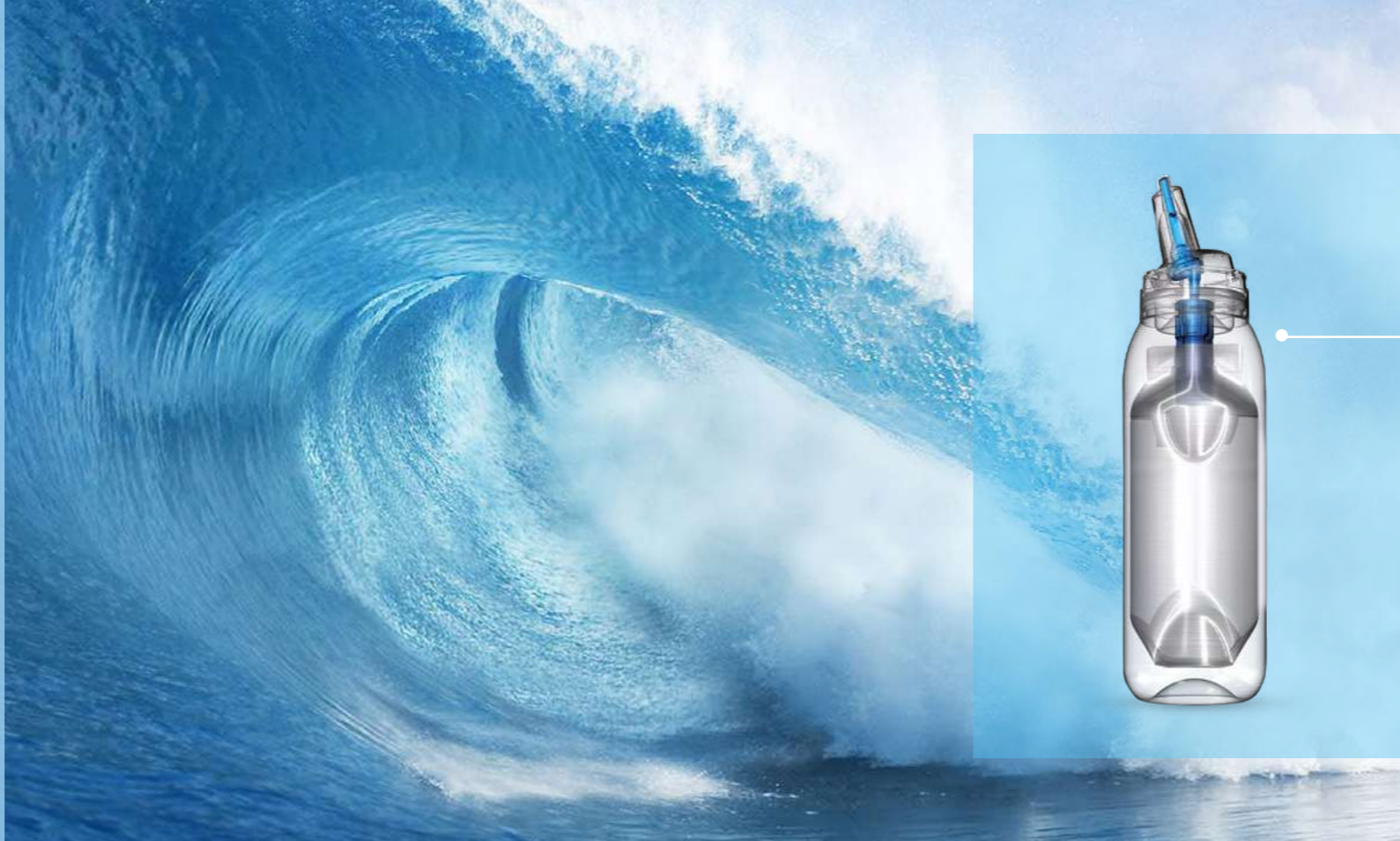

"Bag on Valve" technology

- The bottle works in any position and sprays continuously
- Used to the last drop
- Seawater is sterile during the entire period of use

Isotonic solutions of seawater 0,9 %

Hypertonic solutions of seawater 2,1 %



Baby

MD 0+

- **Release form:**
BOV aerosol 150 ml (with "soft shower" nozzle)
- BFS unidose 2 ml No. 30

Soft

MD 1+

- **Release form:**
BOV aerosol 150 ml (with "shower" nozzle)

Norm

MD 2+

- **Release form:**
BOV aerosol 150 ml (with "stream" nozzle)

Forte

MD 2+

- **Release form:**
BOV aerosol 150 ml (with "stream" nozzle)
- metered spray, nasal 30 ml

Forte for throat

MD 2+

- **Release form:**
BOV aerosol 150 ml (with "shower" nozzle for mouth and throat)

LOROTOX®

OTC 0+

Composition:
lidocaine 1%, phenazone 4 %

Release form:
bottle with dropper 16 g No. 1

Dosage form:
ear drops

Dual analgesic and anti-inflammatory effect for the complex therapy of acute otitis media

- > Convenient bottle with a screw-on dropper, providing accurate dosing
- > No age restrictions. Can be prescribed to patients of any age (0+)



Indications for use

- > acute exudative otitis media
- > otitis media as a complication after the flu
- > exudative viral otitis
- > barotraumatic otitis



Indications for use

- > external acute and chronic otitis without eardrum damage

NIATIRA

RX 18+

Composition:
rifamycin 2,6 %

Release form:
bottle with dropper 10 ml No. 1

Dosage form:
ear drops

Indications for use

- > acute external otitis
- > exacerbations of chronic otitis media
- > after surgical interventions on the middle ear

OTOLORIN

OTC 18+

Composition:
procaine 20 mg,
boric acid 30 mg

Release form:
pipette bottle 10 ml No. 1

Dosage form:
ear drops

- > Treatment of otitis externa
- > Has antiseptic and local anesthetic effect

- > Improves blood microcirculation in the inflammatory focus



Solopharm ophthalmology portfolio

is represented by all major pharmacotherapeutic groups used in the treatment of eye diseases, and includes anti-glaucoma, antibacterial, anti-inflammatory, anti-allergic, antioxidant drugs, moisturizing, as well as diagnostic drugs

Solopharm medicines are distinguished by:

- > high quality
- > modern production technologies
- > innovative release forms that eliminate preservatives and improve ease of use

Aqua Optic



Indications for use

- > daily cleaning of contact lenses
- > removal of protein deposits
- > washing, disinfection, storage of contact lenses

MD

0+

Composition:
sodium hyaluronate, poloxamer 407, polyhexamethylene biguanide hydrochloride (20% solution), succinic acid, trehalose

Release form:
bottle 60, 120, 250, 450 ml (contact lenses case included)

Dosage form:
multifunctional solution for contact lenses care

A unique solution for gentle cleansing of lenses, gives the eyes a feeling of hydration, protection and comfort

- > Effectively cleans and disinfects
- > Increases the overall comfort of wearing contact lenses
- > Moisturizes for a long time



GYLAN COMFORT / ULTRA COMFORT

MD 0+

no preservatives

Composition:

sodium hyaluronate 0,18 % / 0,3 %

Release form:

OSD bottle 10 ml No. 1

Release form:

BFS unidose 0,4 ml No. 10, 30

Dosage form:

moisturizing ophthalmologic solution

- > Instant and long-lasting hydration
- > Suitable for "dry" eye syndrome treatment

GYLAN® EXTRA

MD 0+ NEW

no preservatives

Composition:

trehalose 3 %, sodium hyaluronate 0,18 %

Release form:

OSD bottle 10 ml No. 1

Release form:

BFS unidose 0,4 ml No. 10, 30

Dosage form:

moisturizing ophthalmologic solution

- > Instant and long-lasting hydration
- > Trehalose in the composition has a beneficial effect on the protection and restoration of the eye
- > Suitable for "dry" eye syndrome treatment

INNOVATIVE OSD BOTTLE (Ophthalmic Squeeze Dispenser)

- guarantees the sterility of the drug with no preservatives throughout the shelf life after opening
- the absence of preservatives minimizes the risk of adverse events
- a special Teflon filter in the bottle purifies the air entering the bottle during instillation and prevents bacterial contamination of the drug



cap

container

Indications for use Gylan comfort, Gylan ultra comfort, Gylan® extra

- > for moisturizing in case of "dry" eye syndrome
- > eliminate the feeling of dry eyes, the feeling of "sand" in the eyes
- > in case of "office" syndrome with burning, tearing, redness, itching, fatigue to eliminate discomfort when wearing hard and soft contact lenses
- > in the complex treatment of chronic blepharitis to eliminate dry eyes in cases of systematic and long-term use of drugs
- > moisturize the anterior surface of the eye after ophthalmic surgery, including after refractive interventions for Sjögren's syndrome

Special design of OSD bottle

shutter cover pin

spring

channels

filter





Unidose

- Sterile polyethylene packaging of a single drug dose
- Convenient and compact
- No preservatives
- Modern BFS technology (Blow-Fill-Seal) — advanced aseptic bottling in one cycle, recognized as the most perfect in the world for the production of sterile medicinal solutions



BIVIART® SOFT / COMFORT / ULTRA

MD 0+



Composition:
sodium hyaluronate 0,1 % / 0,18 % / 0,3 %

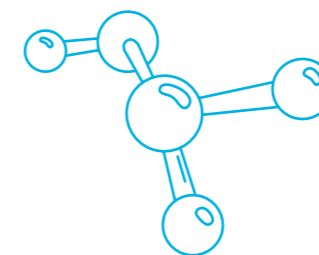

Release form:
multidoses 10 ml No. 1

Dosage form:
moisturizing ophthalmologic solution (with preservatives)



✓ Available segment



DORZIAL

RX 0+ no preservatives

Composition:
dorzolamide 20 mg/ml

Release form:
OSD bottle 10 ml No. 1

Dosage form:
eye drops

- > Reduction of intraocular pressure
- > Protection of corneal cells
- > Moisturizing of the eye surface due to sodium hyaluronate in the composition



Indications for use

for adults with:

- > ophthalmohypertension
- > primary open-angle glaucoma
- > pseudoexfoliative glaucoma
- > secondary glaucoma (without anterior chamber angle block)

for children:

- > for the treatment of glaucoma from 1 week old in monotherapy mode or as an adjunct to treatment with β -drainage blockers



Indications for use

- > for the treatment of increased intraocular pressure in open-angle glaucoma and pseudoexfoliative glaucoma
- > with insufficient effectiveness of monotherapy or ophthalmohypertension
- > with insufficient response to treatment with beta-blockers



Indications for use

- > treatment of symptoms of seasonal allergic conjunctivitis



Indications for use

- > removal of foreign bodies in the eyes
- > prevention of inflammatory processes caused by the getting of foreign bodies into the eye
- > mucosal lavage before administration of medications
- > elimination of discomfort with swelling of the eye

OLORIDINE

RX 3+

Composition:
olopatadine 0,1 %

Release form:
multidoses 5 ml No. 1

Dosage form:
eye drops

- > Pronounced antihistamine effect up to 12 hours
- > Effect starts in 5 minutes
- > Easy-to-press dropper bottle
- > Allowed for children (3+)

DORZIAL PLUS

RX 18+ no preservatives

Composition:
dorzolamide 20 mg/ml, timolol 5 mg/ml

Release form:
OSD bottle 5 ml No. 1

Dosage form:
eye drops

- > Reduction of intraocular pressure
- > Protection of corneal cells
- > Normalization of the ocular surface after 3 months of therapy
- > Prevention of "dry" eye syndrome due to sodium hyaluronate in the composition

OCUSALIN

MD 0+ no preservatives

Composition:
sodium chloride 3 %

Release form:
BFS unidose 2 ml No. 10

Dosage form:
eye wash drops

- > The only hypertonic sodium chloride solution for eye washing in unidoses
- > Sterile solution — eliminates microbial contamination
- > Safe for corneal cells
- > Allowed for pregnant and breastfeeding women

IVINAC®-SOLOPHARM

RX 18+

Composition:
bromfenac 0,09 %

Release form:
multidoses 2,5, 5 ml No. 1

Dosage form:
eye drops

- > The composition is improved by hydroxypropylbeta-dex to increase therapeutic activity
- > Contains a minimal amount of preservative for better tolerability
- > The strike stop allows correctly placing the bottle over the eye without risk of damage to the cornea

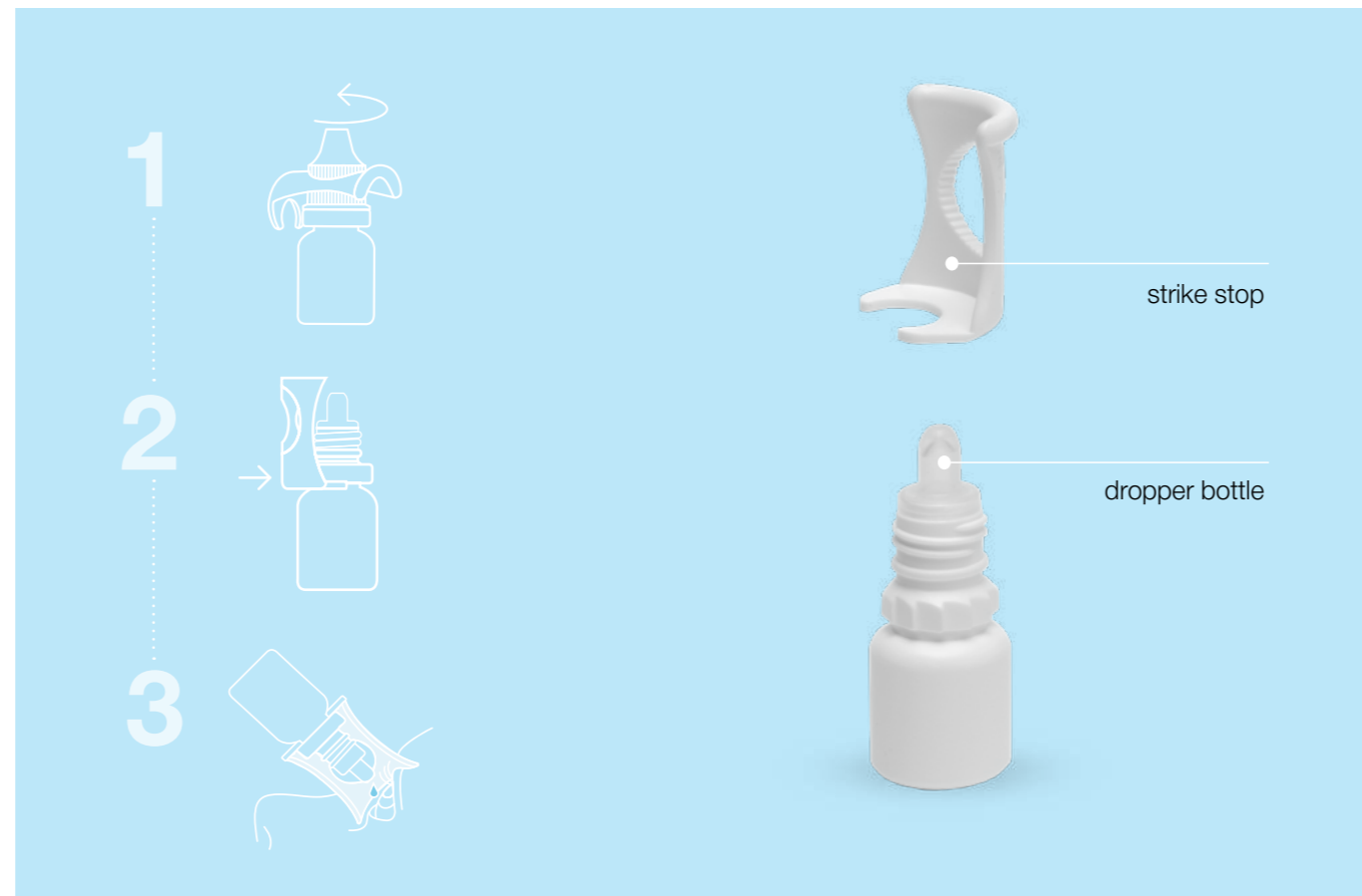

A bottle with a strike stop

- Facilitates the opening of the bottle
- Helps to place the bottle over the eye correctly
- Reduces the risk of corneal injury during instillation
- Prevents eye contact with the bottle
- Designed taking into account the anatomical features of the structure of the eye socket area, so the drop hits exactly in the eye, which significantly reduces the overspending of the drug
- Facilitates instillation, especially for people with joint problems and violations of fine motor skills



Indications for use

- > symptomatic treatment of non-infectious inflammatory diseases of the anterior segment of the eye and postoperative inflammation



Indications for use

- > reduction of increased intraocular pressure for adults and children (1+) with open-angle glaucoma or increased ophthalmotonus

TRILAKTAN®

RX 1+

Composition:
latanoprost 0,005 %

Release form:
multidoses 2,5 ml No. 1, 3

Dosage form:
eye drops

- > Reduces intraocular pressure
- > Produced from a reference substance at low temperature
- > Convenient for instillation exactly in the eye

DORZOLAN® SOLO

RX 0+

Composition:
dorzolamide 2 %

Release form:
multidoses 5 ml No. 1

Dosage form:
eye drops

> Contains hyaluronic acid



Indications for use

> anti-glaucoma agent



Indications for use

> cataracts of various genesis

PICTORID-SOLOPHARM

OTC 0+

Composition:
picloxydine 0,05 %

Release form:
multidoses 10 ml No. 1

Dosage form:
eye drops

> Has a wide spectrum of action against bacteria, viruses and fungi

> Approved for use from birth



Indications for use

- > bacterial infections of the anterior part of the eye
- > dacryocystitis
- > prevention of infectious complications in the postoperative period after surgical interventions in the anterior part of the eye



Indications for use

- > symptomatic temporary relief of secondary hyperemia (redness) of the eyes due to moderate irritant effects and allergic conjunctivitis

OFTARINT

OTC 18+

Composition:
adenosine, nicotinamide, cytochrome C

Release form:
multidoses 10 ml No. 1

Dosage form:
eye drops

- > Slowing down the development of cataracts
- > Normalization of metabolic processes of the lens
- > Nutrition and antioxidant protection
- > Used in cases of combined eye pathology with cataract

SIGIDA DUO / CRYSTAL

RX 6+ OTC 2+

no preservatives

Composition:
naphazoline 0,1 %, diphenhydramine 0,033 % / naphazoline 0,05 %

Release form:
OSD bottle 10 ml No. 1

Dosage form:
eye drops

- > Vasoconstrictive eye drops with moisturizing effect
- > Relieves redness, swelling and irritation of the eyes
- > Contains hyaluronic acid for additional moisturizing effect

RX 0+

Composition:
diclofenac 0,1 %

Release form:
multidoses 5 ml No. 1

Dosage form:
eye drops

DICLOFENAC-SOLOPHARM

- > Treatment of non-infectious conjunctivitis and after surgical interventions on the eyeball

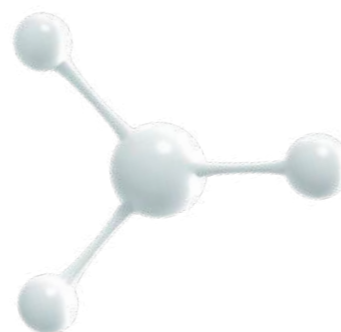

RX 1+

Composition:
levofloxacin 0,5 %

Release form:
multidoses 5 ml No. 1

Dosage form:
eye drops

KORFECIN-SOLOPHARM

- > Low resistance of pathogens
- > High penetrating power
- > Broad-spectrum medicine



RX 0+

Composition:
timolol 0,5 %

Release form:
multidoses 5 ml No. 1

Dosage form:
eye drops

TIMOLOL-SOLOPHARM

- > Reduction of intraocular pressure by reducing the formation of intraocular fluid

RX 0+

Composition:
betaxolol 0,5 %

Release form:
multidoses 5 ml No. 1

Dosage form:
eye drops

BETAXOLOL-SOLOPHARM

- > Improves ocular blood circulation (perfusion)
- > Effectively reduces intraocular pressure and improves ocular circulation
- > The effect starts within 30 minutes and persists for 24 hours

CROMICIL®-SOLOPHARM

OTC 4+

Composition:
cromoglycic acid 2 %

Release form:
multidoses 10 ml No. 1

Dosage form:
eye drops

- > Solves the problems of year-round allergic conjunctivitis
- > Blocks both early and late allergic reactions
- > Seasonal and year-round allergic conjunctivitis

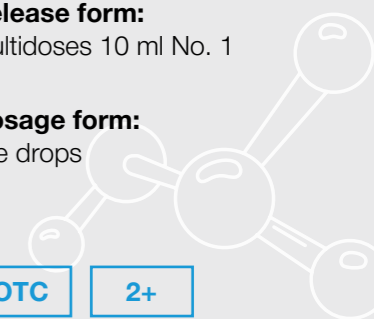

OFTRIX

OTC 2+

Composition:
tetrissoline 0,05 %

Release form:
multidoses 15 ml No. 1

Dosage form:
eye drops

- > Quickly relieves swelling and redness
- > Removal of swelling and hyperemia of the conjunctiva (redness of the eyes) caused by exposure to chemical and physical factors such as smoke, wind, dust, chlorinated water, light, cosmetics, contact lenses

LAFRAX

RX 1+

Composition:
ofloxacin 0,3 %

Release form:
multidoses 5 ml No. 1

Dosage form:
eye and ear drops

- > Broad-spectrum antimicrobial agent from the group of fluoroquinolones
- > High antibacterial activity
- > Approved for children (1+)

TRAVAXAL

RX 18+

Composition:
travoprost 0,004 %

Release form:
multidoses 2,5 ml No. 1

Dosage form:
eye drops

- > The first travoprost produced in Russia
- > A significant decrease in intraocular pressure may persist for 24 hours after a single application of the drug

SOLOSEPTIN SENS

RX 0+

Composition:
benzyltrimethyl (3-(myristoylamino)-propyl) ammonium chloride monohydrate 0,01 %

Release form:
multidoses 10 ml No. 1

Dosage form:
eye, ear and nasal drops

- > A wide range of activity among antiseptics
- > Reduces the resistance of bacteria to antibiotics
- > Provides a local effect



- Indications for use in ophthalmology**
- > complex treatment of infectious processes of the anterior part of the eye (blepharitis, conjunctivitis, keratitis, keratouveitis)
 - > eye injuries, eye burns (thermal and chemical)
 - > in the preoperative and postoperative periods for the treatment and prevention of purulent-inflammatory eye lesions
 - > prevention of neonatal ophthalmia, including gonococcal and chlamydial



- Indications for use**
- > iridocyclitis
 - > "red eye" syndrome (for reducing hyperemia and irritability of the mucous membrane of the eye)
 - > prevention of asthenopia and accommodation disorders in patients with high visual load
 - > treatment of false myopia and prevention of progression of true myopia in patients with high visual load

STELFRIN SUPRA

RX 6+

no preservatives

Composition:
phenylephrine 2,5 %, sodium hyaluronate 0,27 %

Release form:
OSD bottle 10 ml No. 1

Dosage form:
eye drops

- > Comfortable treatment of accommodation disorders
- > Prevention from "dry" eye syndrome by moisturizing the eye surface
- > Sterility of the solution to the last drop

PHENYCAMIDE

RX

12+

Composition:phenylephrine 5 %,
tropicamide 0,8 %**Release form:**

multidoses 10 ml No. 1

Dosage form:

eye drops

> Two components to achieve maximum mydriasis

**Indications for use**

Used as a mydriatic remedy:

- > during diagnostic ophthalmological procedures
- > before surgical and laser operations
- > in case of accommodation disorders (as part of complex therapy)

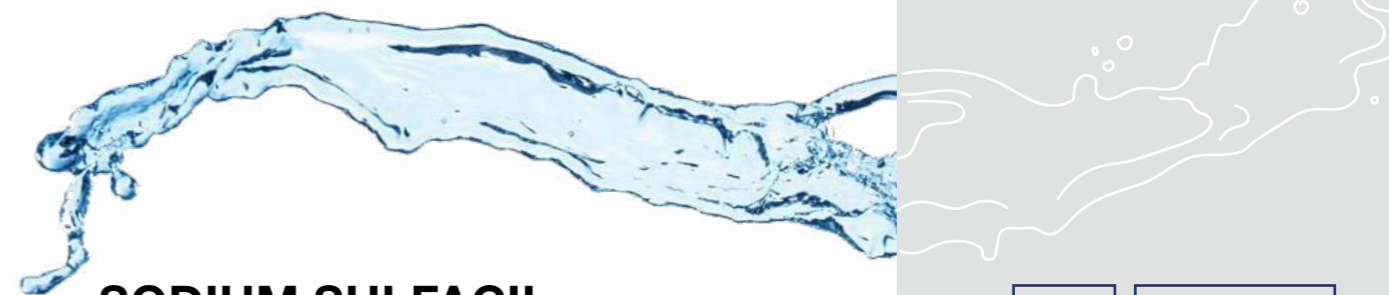

SODIUM SULFACIL-SOLOPHARM

- > Active against gram-positive and gram-negative cocci
- > Sterile solution

OTC

2 months +

no preservatives

Composition:

sulfacetamide 20 %

Release form:

multidoses 5 ml No. 1

unidoses 0,5 ml No. 5

Dosage form:

eye drops

TAFLARINT

- > Reduction of intraocular pressure
- > Convenient to use due to the strike stop

RX

18+

Composition:

tafluprost 0,0015 %

Release form:

multidoses 2,5 ml No. 1

Dosage form:

eye drops

TIMILOX®

- > Used for the treatment of bacterial conjunctivitis
- > Broad-spectrum medicine, including atypical microflora

RX

1+

no preservatives

Composition:

moxifloxacin 0,5 %

Release form:

multidoses 5 ml No. 1

Dosage form:

eye drops

TAUSTIN

OTC

18+

Composition:
taurine 4 %

Release form:
multidoses 10 ml No. 1

Dosage form:
eye drops

- > Stimulates the processes of repair and regeneration of eye tissues
- > Promotes normalization of cell membrane functions, activation of energy and metabolic processes

**Indications for use**

The drug is used as a part of complex therapy:

- > corneal dystrophy, cataract (senile, diabetic, traumatic, radiation)
- > corneal injury (as a stimulant of reparative processes)
- > primary open-angle glaucoma (combined with β -blockers for improving outflow intraocular fluid)

**Indications for use**

mono- and complex therapy of viral eye lesions:

- > conjunctivitis, keratonjunctivitis, keratouveitis caused by herpes virus and adenoviruses
- > keratopathies of infectious, post-traumatic and postoperative genesis

**Indications for use**

> treatment and prevention:

- inflammation and burns of the cornea
- hemorrhages in the anterior chamber of the eye
- hemorrhages in the sclera in the elderly
- thrombosis of the central retinal vein and its branches
- complications of myopia
- diabetic retinopathy
- > protection of the cornea when wearing contact lenses

EXINTA®

OTC

0+

no preservatives

Composition:
aminobenzoic acid 0,007 %

Release form:
multidoses 5 ml No. 1

Dosage form:
eye drops

- > Provides an immunomodulatory effect
- > Accelerates corneal regeneration
- > Enhances the effect of antibiotics

VICSIPIN®

RX

18+

Composition:
methylethylpyridinol 1 %

Release form:
multidoses 10 ml No. 1

Dosage form:
eye drops

- The composition is improved by auxiliary substances:
 - > hydroxypropylbetadex — increases therapeutic activity
 - > sodium hyaluronate — moisturizes the corneal epithelium
- Soft and easy to press dropper bottle
- 10 ml bottle is designed for monthly course of therapy

Solopharm pulmonological portfolio

is represented by bronchodilators and mucoactives, frequently used in medical practice

Solopharm medicines compare favourably with high quality and convenient release form



MDI (Metered Dose Inhaler — metered aerosol for inhalation)

- > Special device for fast delivery of the necessary inhalation dose of the drug directly into the respiratory tract
- > Optimal form of drug delivery for the relief of bronchospasm attack in bronchial asthma, chronic obstructive pulmonary disease and other respiratory diseases

balloon

actuator

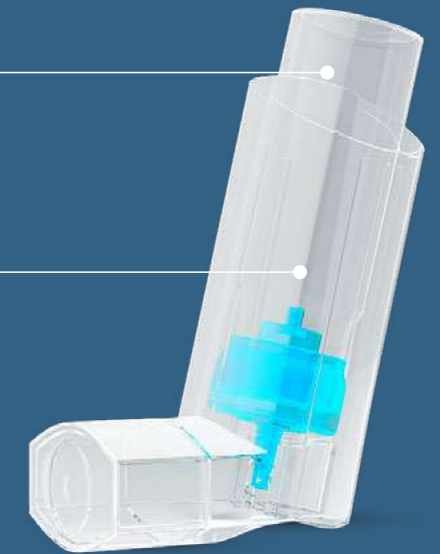

ASTMASOL® BRONCHO

RX 0+

Composition:
ipratropium bromide 0,25 mg/ml,
phenoterol 0,5 mg/ml

Release form:
glass bottle 20 ml No. 1

Dosage form:
solution for inhalation

- > Combined bronchodilator in a bottle with a dropper for flexible dose selection depending on the patient's age or the severity of the bronchospasm attack
- > Allowed from birth
- > Shelf life before opening the bottle is 5 years



Indications for use

prevention and symptomatic treatment of obstructive airway diseases with reversible airway obstruction:

- > chronic obstructive pulmonary disease (COPD)
- > bronchial asthma
- > chronic bronchitis complicated or uncomplicated by emphysema

ASTMASOL® NEO

RX 6+

Composition:
ipratropium bromide 20 mcg/dose,
phenoterol 50 mcg/dose

Release form:
MDI aerosol 200 doses

Dosage form:
metered aerosol for inhalation

- > Combination of ipratropium bromide and phenoterol for "here and now" ambulance with bronchospasm in inhaler designed for the patient
- > High efficiency of the double combination in case of bronchospasm
- > Quick start of action — within 5 minutes
- > Metered dose inhaler is the optimal form of delivery directly to the respiratory tract

INGASALIN®

MD 0+

Composition:
sodium chloride 3 %,
sodium hyaluronate 0,01 %

Release form:
BFS ampoules 5 ml No. 10

Dosage form:
hypertonic sterile solution
for inhalation

The triple mechanism of complex action on the pathogenesis of cough:

- > mucolytic (dilutes sputum)
- > mucokinetic (removes sputum)
- > anti-inflammatory (protects lung tissue)

Allows significantly reduce the intensity of cough already on the 3rd day of treatment and completely stop the cough by the 7th day of therapy

Favorable safety profile, recommended for use from birth

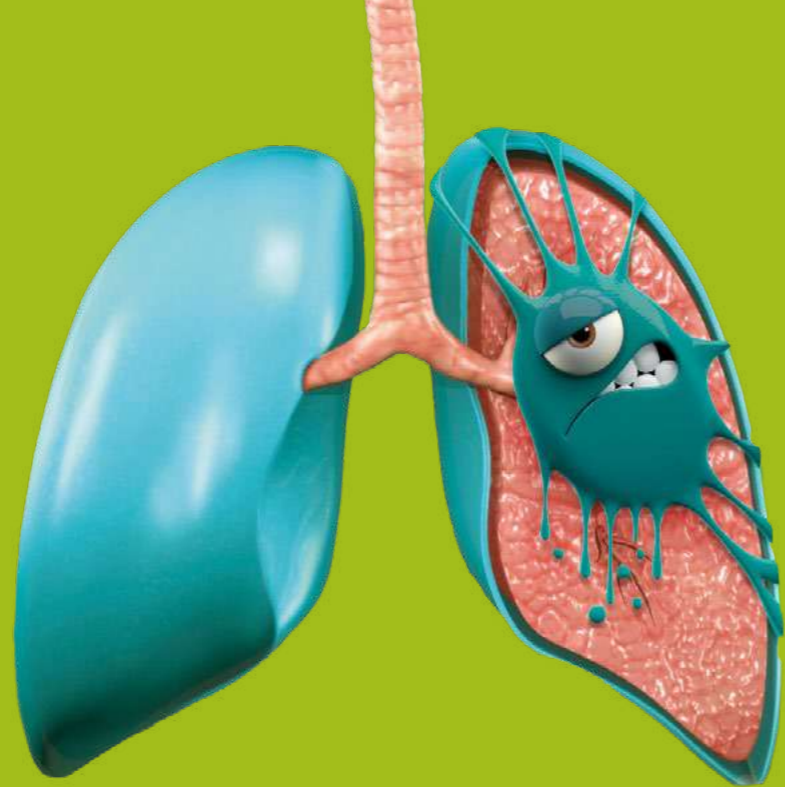

>>
**For everyone who coughs,
even for the youngest ones**

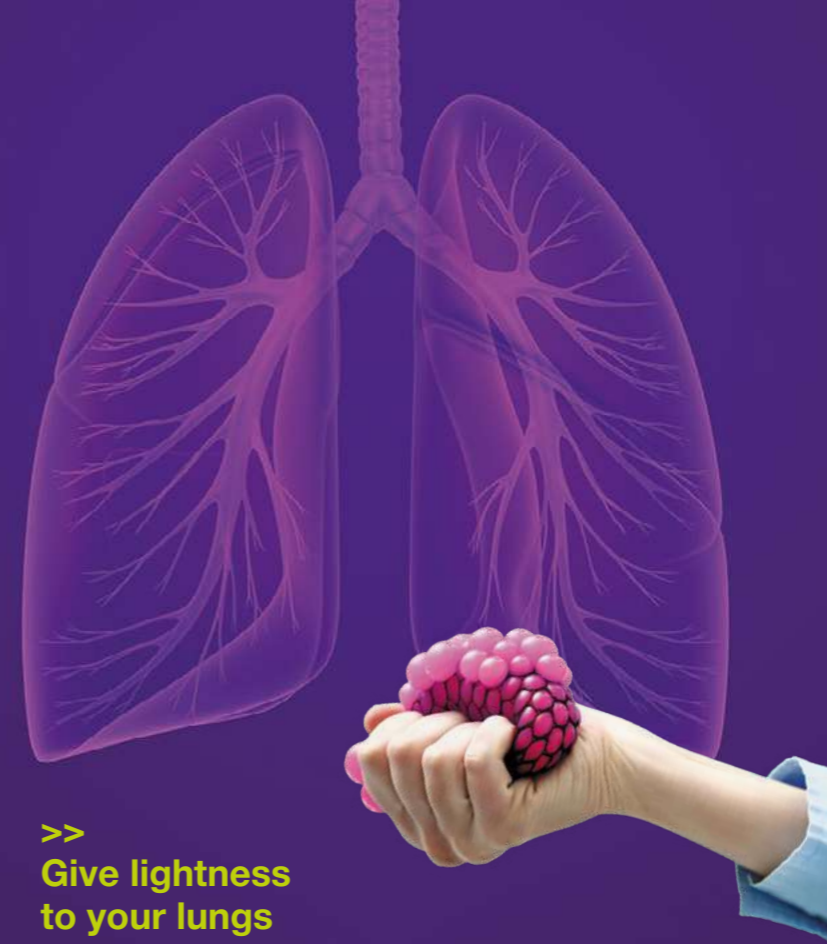

>>
**Give lightness
to your lungs**



Indications for use

- > diseases of the respiratory system, which are accompanied by severe separation of viscous secretions (sputum) in the respiratory tract
- > acute bronchitis
- > exacerbation of chronic bronchitis
- > bronchiectatic disease
- > cystic fibrosis

INGASALIN® FORTE

MD 0+

Composition:
sodium chloride 7 % +
sodium hyaluronate 0,1 %

Release form:
BFS ampoules 5 ml No. 10

Dosage form:
hypertonic sterile solution
for inhalation

The triple mechanism of complex action on the pathogenesis of cough:

- > mucolytic (dilutes sputum)
- > mucokinetic (removes sputum)
- > anti-inflammatory (protects lung tissue)

Ingasalin® forte 7% application twice a day through a nebulizer by patients with acute bronchitis, contributes to a pronounced regression of cough (by 64%) already on the 4th day of treatment

BERAXOL- SOLOPHARM

OTC

0+

Composition:
ambroxol 7,5 mg/ml

Release form:
bottle with dropper 100 ml No. 1

Dosage form:
solution for oral administration
and inhalation

Product form:
BFS unidose 2 ml No. 20
(without solvent)

Dosage form:
solution for oral administration
and inhalation

- > Two release forms — opportunity for patient to select the most convenient therapy
- > Allowed from birth
- > Can be diluted in juice, tea, milk



Indications for use

- acute and chronic respiratory tract diseases with the release of viscous sputum:
- > acute and chronic bronchitis
 - > pneumonia
 - > chronic obstructive pulmonary disease
 - > bronchial asthma with difficulty in sputum discharge

NOVATRON / NOVATRON NEO

RX

0+

Composition:
salbutamol 1 mg/ml

Release form:
BFS ampoules 2,5 ml No. 10, 20

Dosage form:
solution for inhalation

Composition:
salbutamol 100 mcg/dose

Release form:
MDI aerosol 200 doses

Dosage form:
metered aerosol for inhalation

Bronchodilator

- > Quick start of action: within 5 minutes
- > The effect up to 6 hours
- > Convenient release forms (metered dose inhaler and BFS ampoules)



Indications for use

- > prevention and relief of bronchospasm in bronchial asthma
- > symptomatic treatment of bronchoobstructive syndrome, including chronic bronchitis and emphysema of the lungs
- > prevention and treatment of reversible bronchial obstruction, including chronic obstructive pulmonary disease

ArmaViscon®

A wide range of premium quality hyaluronic acid medicines for an individual approach to patients with osteoarthritis

- > Replenishes the deficiency and improves the properties of synovial fluid in diseases of the joints
- > Hyaluronic acid in the composition is as close as possible in properties to the synovial fluid of a healthy joint
- > Reduces soreness and improves joint mobility within 10-15 minutes after administration
- > The effect lasts up to 6 months

Fills the joints with life

Indications for use

- > increases joint mobility and eliminates pain caused by degenerative-dystrophic or post-traumatic joint changes
- > for rehabilitation after arthroscopy
- > for the treatment of patients with increased physical activity and regularly loading the affected joint



ARMAVISCON® VITA

MD 18+

Composition:
sodium hyaluronate
20 mg, 1%

Release form:
pre-filled syringe 2 ml No. 1, 2

Dosage form:
solution for intra-articular
injection

Gentle therapy of osteoarthritis and diseases of the periarticular soft tissues in elderly and inactive patients

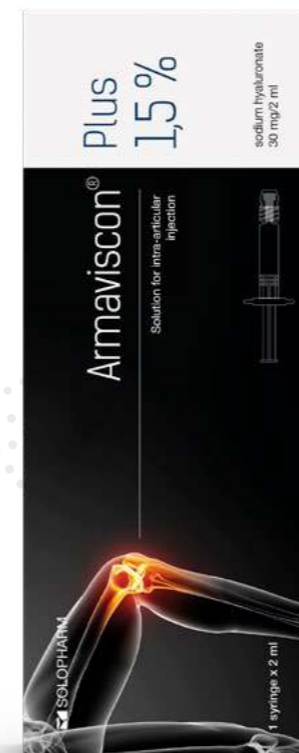
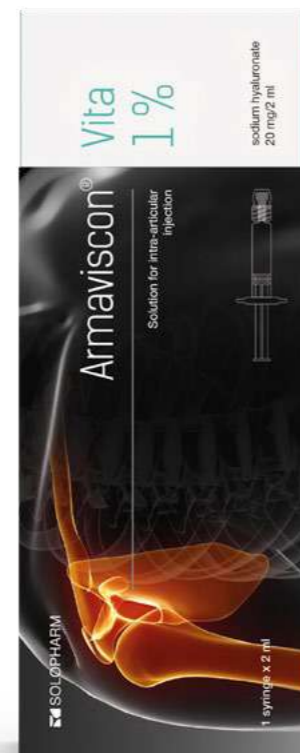

ARMAVISCON® PLUS

MD 18+

Composition:
sodium hyaluronate
30 mg, 1,5 %

Release form:
pre-filled syringe 2 ml No. 1, 2

Dosage form:
solution for intra-articular
injection

A universal solution for the gentle therapy of osteoarthritis, including chronic sluggish inflammation

ARMAVISCON® FORTE

MD 18+

- Composition:** sodium hyaluronate 69 mg, 2,3 %
- Release form:** pre-filled syringe 3 ml No. 1
- Dosage form:** solution for intra-articular injection
- 1 injection for maximum joint protection even at high loads on the joint

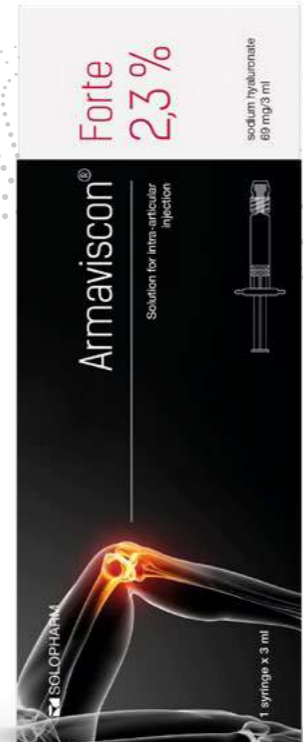

ARMAVISCON® PLATINUM

MD 18+

- Composition:** sodium hyaluronate 90 mg, 3 %
- Release form:** pre-filled syringe 3 ml No. 1
- Dosage form:** solution for intra-articular injection
- Maximum concentration of hyaluronic acid in 1 syringe for protection of joints in special cases and with regular heavy loads

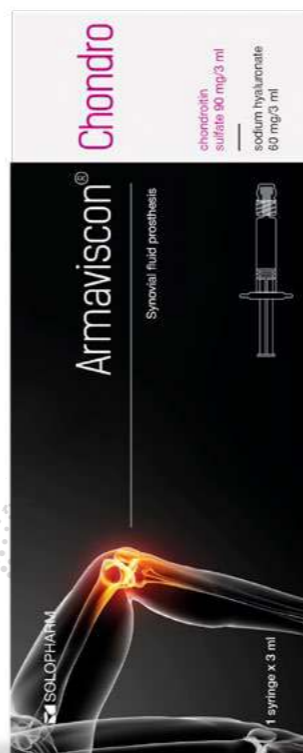

ARMAVISCON® MN

MD 18+

- Composition:** sodium hyaluronate 40 mg, 2 %, mannitol 10 mg, 0,5 %
- Release form:** pre-filled syringe 2 ml No. 1
- Dosage form:** solution for periarticular and intra-articular injection
- Synergistic combination of hyaluronic acid and mannitol to relieve inflammation and restore the functions of joints and tendon-ligamentous apparatus

ARMAVISCON® CHONDRO

MD 18+

- Composition:** sodium hyaluronate 60 mg, 2 %, chondroitin sulfate 90 mg, 3 %
- Release form:** pre-filled syringe 3 ml No. 1
- Dosage form:** synovial fluid prosthesis
- Hyaluronic acid enhanced with chondroitin for a faster and more pronounced analgesic effect and start the process of regeneration of the joint

ARTAVISK

MD 18+ NEW

Composition:
sodium hyaluronate 30 mg +
polynucleotides 30 mg +
mannitol 108 mg

Release form:
pre-filled syringe 3 ml No. 1

Dosage form:
solution for intra-articular
and peritendinous injection

**The first combined
medicine of hyaluronic
acid with polynucleotides
on the Russian market**
for deep cartilage restoration

- > Promotes:**
- reduction of pain syndrome
 - restoring functions and joint mobility and tendons
 - activation of exchange and restorative processes in cartilage and slowing down age-related changes
 - improving elasticity cartilage and ligaments



- Indications for use**
- > increases joint mobility and eliminates pain in joint diseases
 - > increases tendon mobility and eliminates pain caused by tendon diseases
 - > during the rehabilitation period after injuries and surgical interventions



- Indications for use**
- > increases mobility, eliminates pain caused by joint diseases
 - > as a part of complex therapy for patients with increased physical activity and regularly loading the affected joint
 - > for rehabilitation after arthroscopy

SINTALON

MD 18+ NEW

Composition:
sodium hyaluronate 24 mg

Release form:
pre-filled syringe 3 ml No. 1

Dosage form:
synovial fluid prosthesis

A unique combination
of cross-linked sodium
hyaluronate with optimal
rheological properties
and mannitol

- > Promotes:**
- reduction of pain syndrome and inflammation
 - protection of articular surfaces during intense loads;
 - long-term therapeutic effect — 6 months +

ACT SOLOPHARM®

MD

Release form:
double syringe



A specially designed unified system for the safe and rapid production of autologous plasma rich in platelets and growth factors [PRP — Platelet Rich Plasma]



PRP OR PLASMA THERAPY using autologous plasma —

non-surgical recovery method and rejuvenation of the body, based on the injection of the patient's own blood plasma enriched with platelets and growth factors

The method has been widely used in various areas

- > traumatology and orthopedics
- > ophthalmosurgery
- > gynecology
- > cosmetology
- > dentistry
- > trichology

Advantages of the method

- > **The effectiveness** of autologous plasma therapy has been proven in multicenter randomized researches
- > **Naturalness** — autoplasm is isolated from the patient's own blood, has a high degree of biocompatibility, so that the risk of allergic reactions is minimized

UNIVERSAL
one device for the entire PRP procedure with an adjustable volume of the resulting plasma

STERILE
a completely closed system eliminates the contact of the collected blood with the external environment

FAST
the plasma production process takes no more than 5 minutes*

- > Up to 8 ml of plasma in one syringe
- > Platelet concentration is 2 – 2,5 times higher compared to whole blood



*the time of centrifugation is indicated

PRP syringe

DETRIFEROL

OTC

4 weeks +

Composition:

colecalfiferol 15 000 IU/ml

Release form:

bottle with dropper 15 ml No. 1

Dosage form:

drops for oral administration

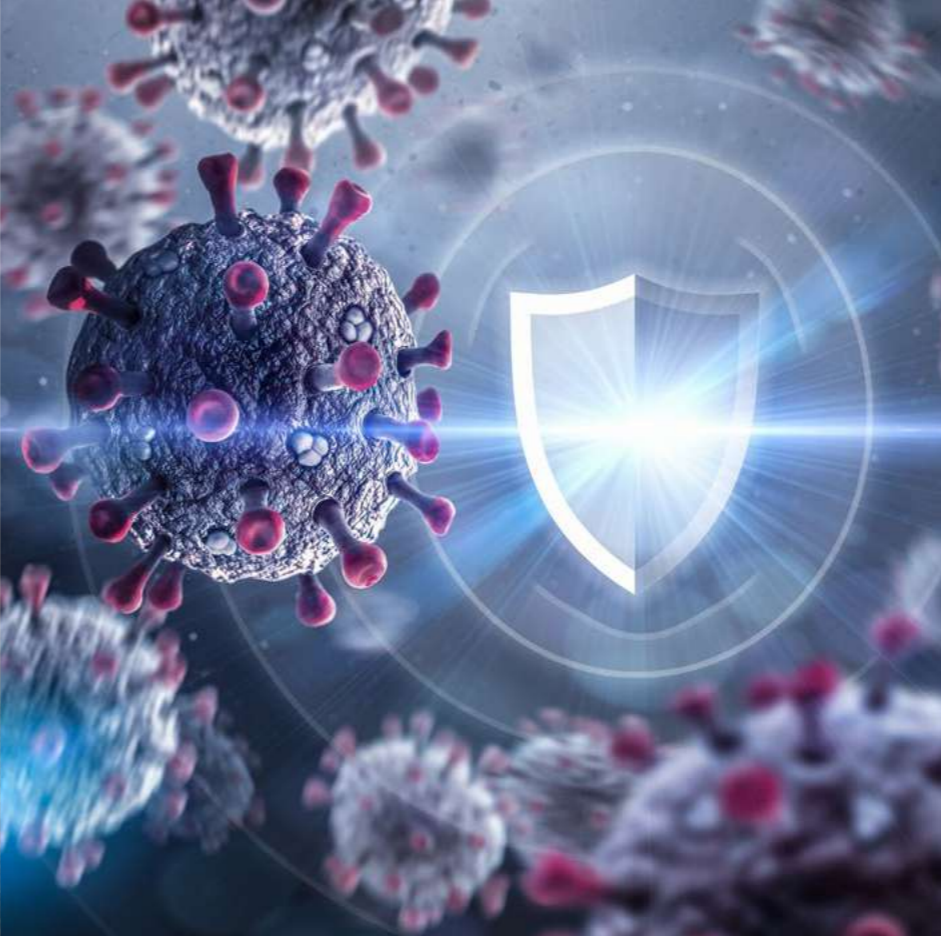

TREKREZAN®

OTC

12+

Composition:

oxyethylammonium methylphenoxyacetate 200 mg

Release form:

tablets in a blister No. 10, 20

Composition:

oxyethylammonium methylphenoxyacetate 20 mg/ml

Release form:

glass bottle 100 ml No. 1

Dosage form:

syrup for oral administration



Indications for use

- > prevention of vitamin D₃ deficiency and treatment of diseases associated with its deficiency for adults and children (4 weeks +)



Indications for use

- > prevention and treatment of acute respiratory viral infections for adults and children
- > strengthening immunity
- > recuperation

- > An aqueous solution of vitamin D₃ is absorbed better than an oil solution
- > Suitable for children and adults
- > 4 flavors: orange, banana, cherry and anise

- > Stimulates the pathway α- and γ-interferons, providing prompt and long-lasting antiviral effect

PICODINAR

OTC 0+

Composition:
sodium picosulfate 7,5 mg/ml

Release form:
multidoses 15, 30 ml No. 1

Dosage form:
drops for oral administration

A mild laxative with a predictable effect

- > Stimulates the natural process of evacuation from the lower gastrointestinal tract
- > Convenient to use due to the lack of connection with food intake



Indications for use

- > constipation caused by atony and hypotension of the colon
- > constipation caused by taking medications
- > constipation caused by intestinal dysbiosis, violation of diet
- > gallbladder diseases, irritable bowel syndrome with predominance of constipation



Indications for use

- > used to treat iron deficiency
- > for rapid replenishment of iron reserves with a clinical need
- > in patients who do not tolerate oral iron preparations or do not follow the treatment regimen
- > in the presence of active inflammatory bowel disease, when oral iron preparations are ineffective



Indications for use

- > relieves nasal and ocular symptoms of year-round and seasonal allergic rhinitis and allergic conjunctivitis: itching, sneezing, nasal congestion, rhinorrhea, lacrimation
 - > relieves the symptoms of chronic idiopathic urticaria
- *use for children from 6 to 12 months is possible only by doctor's prescription and under strict medical supervision

TRICOMBIA

RX 18+

Composition:
iron (III) hydroxide sucrose complex 20 mg/ml

Release form:
CBP injection ampoules
2 ml No. 10, 5 ml No. 5

Dosage form:
solution for intravenous administration

SOLONEKS

OTC 6 months +

Composition:
cetirizine 7,5 mg/ml

Release form:
bottle with dropper 20 ml No. 1

Dosage form:
drops for oral administration

For the treatment of various types of allergies for adults and children (6 months +)

- > the action starts in 20 minutes after taking
- > the effect up to 24 hours

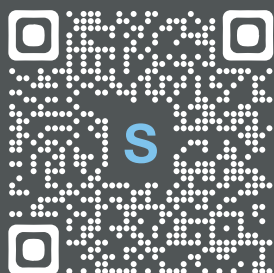

GROTEX LLC,

tel.: +7 812 385 47 87

www.solopharm.com

> Saint Petersburg

Plant: Industrialny Ave., 71/2 lit. A

Office: Lvovskaya str., 27, business center
"Office L27"

> Moscow

Office: Butyrsky Val str., 10
Business Center "White Square"

 **SOLOPHARM**